

Directions for Use

Patient Controlled Analgesia (PCA) Module, 8120 Series

ALARIS Medical Systems, Inc.
Medley™ Medication Safety System

PCA MODULE
MODEL 8120

THIS PAGE
INTENTIONALLY
LEFT BLANK

TABLE OF CONTENTS

INTRODUCTION

ABOUT THE SYSTEM	1
FEATURES AND DEFINITIONS	3
SYMBOLS	6

GETTING STARTED

WARNINGS AND CAUTIONS	7
CONTROLS AND INDICATORS	14
INSTALLATION	15
Unpacking PCA Module	15
ATTACHING AND DETACHING MODULES	15
DISPLAYS	15
Main Display	16
PREPARING SYRINGE AND ADMINISTRATION SET	16
ATTACHING AND DETACHING DOSE REQUEST CORD	17
START-UP	18
Powering On System	18
Responding to Maintenance Reminder	18
Choosing YES or NO to New Patient? and Profile?	18
Selecting Profile	18
Entering Patient ID	18
PREPARING INFUSION	19
Loading Syringe and Administration Set	19
Security Lock Key Positions	21
Selecting Syringe Type and Size	22
Priming	23
Programming an Infusion	25
PCA INFUSION MODES	29
PCA Module Programming Parameters	29
Setting Up PCA Dose Only	29
Setting Up Continuous Infusion Only	32
Setting Up PCA Dose + Continuous Infusion	34
Setting Loading Dose Only	37
Setting Bolus Dose	39
Stopping a Loading, PCA or Bolus Dose	40
Changing Programming Parameters During an Infusion	41
Viewing Patient History	43
Clearing Patient History	45
Viewing Drug Event History	47
Configuring Dose Request Cord	48
Security Access Levels	50
Pausing Infusion	51
Restoring Infusion Following Syringe Empty	52
Stopping Infusion	53
Selecting Pressure Limit	53
Viewing and Clearing Volume Infused	54
Changing Syringe During Infusion	55
POWERING OFF	56
Powering Off Channel	56
Powering Off System	56

INTRODUCTION

GETTING STARTED

ALARMS, ERRORS,
MESSAGES

MAINTENANCE

APPENDIX

ALARMS, ERRORS, MESSAGES

DEFINITIONS 57
AUDIO CHARACTERISTICS 58
ALARMS 59
 Syringe Adjustment Alarms 60
ERRORS 61
MESSAGES 61

MAINTENANCE

SPECIFICATIONS 63
CONFIGURABLE SETTINGS 65
 System Settings 65
 PCA Module Settings 66
COMPATIBLE SYRINGES 67
COMPATIBLE SETS 67
CLEANING 68
INSPECTION REQUIREMENTS 68
SERVICE INFORMATION 69

APPENDIX

TRUMPET AND START-UP CURVES 71

GENERAL CONTACT INFORMATION

Customer Advocacy - North America

Clinical and technical feedback.

Phone: (800) 854-7128, Ext. 7812

E-Mail: CustomerFeedback@alarismed.com

Technical Support - North America

Maintenance and service information support; troubleshooting.

United States:

Phone:

(858) 458-6003

(800) 854-7128, Ext. 6003

Canada:

Phone:

Eastern: (800) 908-9918

Western: (800) 908-9919

Customer Care - North America

Instrument return, service assistance, and order placement.

United States:

Phone:

(800) 482-4822

Canada:

Phone:

(800) 387-8309

THIS PAGE
INTENTIONALLY
LEFT BLANK

About the System

The Medley™ Medication Safety System is a modular infusion and monitoring system intended for use in today's growing professional healthcare environment, for use in adult, pediatric and neonatal care. The Medley™ Medication Safety System consists of the Point-of-Care Unit (PCU) (8000 Series), the Guardrails® Safety Software, and up to four detachable modules which provide infusion or monitoring capabilities.

The Medley™ PCU controls the Medley™ System and provides a common user interface for programming and monitoring an infusion, which helps to reduce complexity at the point of care.

The Medley™ Patient Controlled Analgesia (PCA) Module (Model 8120) is intended for facilities that utilize syringe pumps for the delivery of medications or fluids using continuous or intermittent delivery through clinically acceptable routes of administration; such as, intravenous (IV), subcutaneous or epidural.

The Guardrails® Safety Software for the Medley™ System brings a new level of medication error prevention to the point of patient care. The Guardrails® Safety Software features hospital-defined medication dosing guidelines for up to ten patient-specific care areas, referred to as profiles. Each profile contains a specific drug library and channel labels, as well as instrument configurations appropriate for the care area. Optional drug-specific Guardrails® Clinical Advisories provide visual messages. Dosing limits for each drug entry may be either Guardrails® Hard Limits that cannot be overridden during infusion programming, or Guardrails® Soft Limits that can be overridden, based on clinical requirements.

A data set is developed and approved through the facility's own multi-disciplinary team using the Guardrails® Editor, the PC-based authoring tool. A data set is then transferred to the Medley™ System by qualified personnel. The approved data sets are maintained by the Guardrails® Editor for future updates and reference. A data set is required prior to using the Medley™ PCA Module.

Information about Guardrails® Alerts that occur during use are stored within the Medley™ PCU, and can be accessed using the Guardrails® Continuous Quality Improvement (CQI) Event Tracker and Guardrails® CQI Reporter.

About the System (Continued)

This document provides directions for use for the Medley™ PCA Module. Read all instructions, for both the Medley™ PCA Module and the Medley™ PCU before using the Medley™ System.

The Medley™ PCA Module uses non-dedicated standard or pre-filled, single-use, disposable syringes (with luer-lock connectors) and administration sets with anti-siphon valves, designed for use on syringe-type PCA devices. For specific administration set instructions, refer to the directions for use provided with the set. For set priming and loading instructions, refer to the “Preparing Infusion” section in the “Getting Started” chapter of this document.

Contraindications: None known.

Features and Definitions

Refer to the “Alarms, Errors, Messages” chapter of this Directions for Use for the definitions of various alerts. Refer to the Medley™ PCU Directions For Use for system features and definitions.

Auto Pressure Limit Adjustment	When a bolus is delivered, the pressure alarm limits are temporarily raised to the maximum limit.
Auto Syringe Identification	The system automatically detects the syringe size and narrows down the syringe selection list.
Bolus Dose	The Bolus Dose feature enables a clinician to program an additional amount of medication once the PCA infusion has begun. The current PCA infusion will resume following the delivery of a bolus dose.
Dose Request Cord	When attached, the dose request cord allows a patient to self-administer a PCA dose to be delivered according to programmed PCA parameters. The dose request cord features an indicator light which can be configured to provide feedback to the patient on requested PCA doses. The dose request cord is enabled in PCA only and PCA + Continuous modes.
Drug Event History	Records and displays sequential device events for a typical 12 hours, subject to change upon usage and number of modules.
Event Logging	Event Logging records instrument operations.
Guardrails® Clinical Advisory	A Guardrails® Clinical Advisory is a visual message that appears when a designated drug is selected, to remind a clinician of specific hospital standards of practice when programming an IV medication. A specific clinical advisory can be associated with a selected drug within any of the patient care profiles.
Guardrails® Drug Library	The Guardrails® Drug Library feature is a drug calculation mode available when the Profiles feature is enabled. It provides a hospital-defined list of drugs and concentrations appropriate for use in as many as 10 profiles. Using the Drug Library automates programming steps, including the drug name, drug amount and diluent volume, and activates the hospital-established best-practice Guardrails® Limits. A Guardrails® Safety Software data set is required prior to using the Medley™ PCA Module.

Features and Definitions (Continued)

Guardrails® Limit	<p>A Guardrails® Limit is a programming limit or best-practice guideline for programming a dose limit parameter or instrument configuration determined by the hospital/health system and entered into the system's data set. Dose limits can be defined by the hospital/health system as either "hard" or "soft" limits.</p> <ul style="list-style-type: none">• A Guardrails® Hard Limit is a programmed limit that cannot be overridden.• A Guardrails® Soft Limit is a programmed limit that can be overridden.
Loading Dose	<p>The Loading Dose enables a clinician to program a bolus infusion prior to initiation of the PCA infusion. The Loading Dose may be programmed from the Infusion Modes menu or applicable PCA, PCA + Continuous or Continuous Only programming screen prior to the start of a new PCA infusion program.</p>
Lockout Interval	<p>Allows the clinician to program a pre-determined interval of time that must elapse between delivery of PCA doses.</p>
Occlusion Pressure	<p>Downstream occlusion alarm threshold can be set to low, medium, or high.</p>
Operating Modes	<p>The PCA Module has four operating modes available:</p> <ul style="list-style-type: none">• PCA only• Continuous Infusion• PCA + Continuous Infusion• Loading Dose Only <p>All programming of infusions in each of the four modes are completed using the Guardrails® Drug Library.</p>
Near End of Infusion (NEOI)	<p>The NEOI option allows an alert to be configured to sound anywhere between 5 - 25% volume remaining.</p>

Features and Definitions (Continued)

Patient History	<p>The PCA Module records and displays patient history for up to 24 hours, and may be trended to the following intervals: 1hr/2hr/4hr/8hr/12hr/24hr. Patient history includes the following trending information:</p> <ul style="list-style-type: none">• Total demands• Delivered demands• Total drug delivered• Time and date patient history last cleared• Average drug per hour• Total amount of drug delivered via:<ul style="list-style-type: none">➢ PCA Dose➢ Continuous Infusion➢ Loading Dose➢ Bolus Dose
PCA Dose	<p>The PCA Dose enables a patient to self-administer a bolus infusion to be delivered at programmed lockout intervals through the dose request cord. When programmed in the PCA+Continuous mode, the continuous infusion will resume following the PCA dose.</p>
Priming	<p>The Priming option allows a limited volume of fluid to be delivered in order to prime the administration set prior to being connected to a patient or after changing a syringe. When priming, a single continuous press of the PRIME soft key delivers up to 2 mL of priming/fluid.</p>
Restore	<p>To simplify programming, the Restore feature can be used to recall previous PCA programming parameters for the same patient. This option is only available if the patient is not new and the system is powered up within 8 hours of last usage.</p>
Syringe Empty	<p>The instrument gives an alert and stops when an empty syringe is detected.</p>
Syringe Volume Detection	<p>The system automatically detects the fluid volume in a syringe when it is inserted.</p>

Symbols



Canadian and U.S. Certification Mark: Products bearing this mark have been tested and certified in accordance with applicable U.S. and Canadian electrical safety and performance standards (CSA C22.2 No. 601.1, UL 60601-1 and IEC 60601-2-24).



Electrical Shock Protection Rating: Type CF, Defibrillation-proof (PCA Module)



Electrical Shock Protection Rating: Type BF, Defibrillation-proof (Dose Request Cord)

IPX1

Protection against fluid ingress: Drip Proof



Attention: Refer to accompanying documentation.



IUI Connector: Inter-Unit Interface connector used to establish power and communications between the Point-of-Care Unit and attached channels.



Manufacturing Date: Number adjacent to symbol indicates the month and year of manufacture.



Consult operating instructions.

R_x Only

CAUTION: Federal (U.S.A.) law restricts this device to sale by or on the order of a physician.

Single-Use



Single-Use. Do not re-use.



Product contains a particular element; such as,  = DEHP in fluid pathway.



Product DOES NOT contain a particular element; such as,  = administration set is latex-free.



Approximate administration set priming volume.



Expiration date for product will be identified near hour glass symbol.



Do not use if package is damaged.



Administration set with filter may be used.

NOTE: Although the Medley™ Medication Safety System is built and tested to exacting specifications, it is not intended to replace the supervision of IV infusions by medical personnel. The user should become thoroughly familiar with the features and operation of the Medley™ System and exercise vigilance in its utilization.

Rx Only

A **WARNING** is an alert describing the potential for serious consequences to the patient or user; such as, death, injury or adverse reactions.

A **CAUTION** is an alert to take special care for the safe and effective use of the device.

For WARNINGS and CAUTIONS for the The Medley™ Point-of-Care Unit, refer to the The Medley™ Point-of-Care Unit Directions for Use.

Warnings and Cautions

WARNING

When properly secured/snapped, the bottom latch provides a very secure connection between modules. If not properly latched, a module can be dislodged during operation.

WARNING

Do not use the Medley™ System in close proximity of Magnetic Resonance Imaging (MRI).

WARNING

This instrument is designed to stop fluid flow under alarm conditions. Periodic patient monitoring must be performed to ensure the infusion is proceeding as expected.

WARNING

The Guardrails® Safety Software incorporates dosing limits and instrument configuration parameters based on hospital protocol. The software adds a test of reasonableness to drug programming based on the limits defined by the hospital. Qualified personnel must ensure the appropriateness of the drug dosing limits, the compatibility of the drugs, and the performance of each instrument, as part of the overall infusion. Potential hazards include drug interactions, and inappropriate delivery rates and pressure alarms.

Warnings and Cautions (Continued)

WARNING

When loading a data set with the Guardrails® Safety Software, ensure the correct profile (for patient care area) is selected prior to starting an infusion. Failure to use the appropriate profile could cause serious consequences.

WARNING

The Medley™ PCA Module is a positive displacement delivery system, capable of developing positive fluid pressures to overcome widely varying resistances to flow encountered in practice, including resistances to flow imposed by small gauge catheters and filters. It is neither designed nor intended to detect infiltrations and will not alarm under infiltration conditions.

WARNING

Hospital personnel must ensure the compatibility of the drugs as well as the performance of each channel as part of the overall infusion. Potential hazards include drug interactions, inaccurate delivery rates, inaccurate pressure alarms and nuisance alarms.

WARNING

Use only standard or pre-filled, single-use, disposable syringes (with luer-lock connectors) and non-dedicated administration sets with anti-siphon valves, designed for use on syringe-type PCA devices. The use of any other syringe or administration set may cause improper instrument operation, resulting in inaccurate fluid delivery, or other potential hazards. For a list of compatible syringes, refer to the “Compatible Syringes” section in the “Maintenance” chapter. For a list of compatible administration sets, refer to the Set Compatibility Card (provided separately and in this Directions for Use).

WARNING

Before loading or unloading the syringe, always turn off fluid flow to the patient, using the tubing clamp or stopcock. Uncontrolled fluid flow can occur when the administration set is not clamped or turned off, and may cause serious injury or death.

WARNING

When an occlusion occurs, there is a risk of infusing pressurized buildup of infusates upon correction of the occlusion. To avoid an inadvertent bolus, relieve the pressure before restarting the infusion.

Warnings and Cautions (Continued)

WARNING

When priming:

- Ensure patient is not connected.
- Ensure air is expelled from line prior to beginning infusion (unexpelled air in line could have serious consequences).

Failure to prime correctly can delay infusion delivery and cause the total volume to be infused to read higher than the actual total delivered to the patient.

WARNING

Ensure the syringe manufacturer and syringe size displayed matches the syringe manufacturer and syringe size installed in the Medley™ PCA Module. Mismatches may cause an under-infusion or over-infusion to the patient that could result in serious injury and/or death. For a list of compatible syringes, refer to the “Compatible Syringes” section in the “Maintenance” chapter.

WARNING

The use of positive displacement infusion devices ported together with gravity flow infusion systems into a common IV site may impede the flow of common “gravity only” systems, affecting their performance. Hospital personnel must ensure the performance of the common IV site is satisfactory under these circumstances.

WARNING

Each time the Medley™ System is turned on, verify and/or set the pressure alarm limit. If the pressure alarm limit is not verified, the instrument may not operate within the desired occlusion detection parameter(s).

WARNING

References in this document to specific drugs and drug doses are for illustration purposes only. Refer to specific drug product labeling for information concerning appropriate administration techniques and dosages.

Warnings and Cautions (Continued)

WARNING

When the Medley™ PCA Module is used with a primary IV line, use of an appropriate Y-set with a backcheck valve is highly recommended. Failure to properly use a Y-set may result in retrograde analgesic flow into the primary line during a partial or complete downstream occlusion. This may subsequently result in an inadvertent bolus to the patient when the occlusion is cleared.

Parallel Infusions

There are no contraindications regarding the use of the Medley™ System with any other positive displacement infusion device when ported together into a common IV site location.

User Precautions

To ensure proper performance of the Medley™ System and to reduce potential injury, observe the following precautions:

- Potent analgesic medications are used with this device. Refer to drug package insert for precautions and possible adverse reactions.
- Refer to analgesic package enclosure for possible incompatibility with fluid or drug being delivered through the maintenance line.
- It is recommended that highly viscous solutions and drugs, colloidal suspensions and emulsions should not be delivered through the inline backcheck valve on the maintenance side of the PCA set. Valve functionality may be compromised by the presence of residue.
- Disconnect from main (AC) power when performing maintenance.
- Do not open the instrument case. The case should only be opened by qualified service personnel using proper grounding techniques.

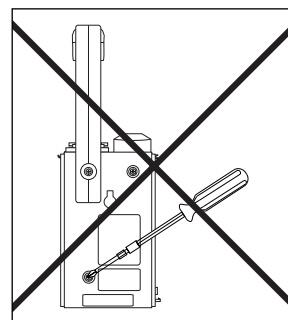

Warnings and Cautions (Continued)

User Precautions (Continued)

Epidural Administration

The Medley™ PCA Module can be used for epidural administration of anesthetic and analgesic drugs. This application is only appropriate when using analgesics and anesthetics labeled for continuous epidural administration and catheters intended specifically for epidural use. Use only standard, single-use, disposable syringes (with luer-lock connectors) and administration sets, designed for use on syringe pumps and **without** a ‘Y’ connector or injection port, for epidural infusions.

- Epidural administration of anesthetic drugs: Use indwelling catheters specifically indicated for short-term anesthetic epidural drug delivery.
- Epidural administration of analgesic drugs: Use indwelling catheters specifically indicated for either short-term or long-term analgesic epidural drug delivery.

Dose Request Cord Use

- Only the patient should press the dose request cord button.

Administration Sets and Syringes

- For a list of compatible syringes, refer to “Compatible Syringes” section in “Maintenance” chapter.
- For a list of compatible administration sets, refer to Set Compatibility Card (provided separately and in this Directions for Use).
- For specific administration set instructions, refer to Directions For Use provided with set. For set priming and loading instructions, refer to “Preparing Infusion” section of this document.
- Before operating instrument, verify that administration set is free from kinks and installed correctly in instrument.
- The administration sets compatible with the Medley™ PCA Module are supplied with a sterile fluid path for one-time use. Do not resterilize.
- Fluid path is STERILE and NONPYROGENIC.
- Discard if packaging is not intact or protector caps are unattached.
- For administration set replacement interval, refer to facility protocol and/or government standards (such as, CDC guidelines in the United States).
- For IV push medication, put instrument on hold, clamp tubing above the port.
- Flush port(s) per facility protocol.
- Discard administration set per facility protocol.

WARNING

Epidural administration of drugs other than those indicated for epidural use could result in serious injury to the patient.

WARNING

It is strongly recommended that the syringe, administration set, and the Medley™ PCA Module used for epidural drug delivery be clearly differentiated from those used for other types of administration.

WARNING

Use only standard or pre-filled, single-use, disposable syringes (with luer-lock connectors) and non-dedicated administration sets with anti-siphon valves, designed for use on syringe-type PCA devices. The use of incompatible syringe or administration set may cause improper instrument operation, resulting in inaccurate fluid delivery, or other potential hazards. For a list of compatible syringes, refer to the “Compatible Syringes” section in the “Maintenance” chapter. For a list of compatible administration sets, refer to the Set Compatibility Card (provided separately and in this Directions for Use).

Warnings and Cautions (Continued)

User Precautions (Continued)

Artifacts

It is normal for an infusion device to produce nonhazardous currents when infusing electrolytes. These currents vary proportional to the infusion device flow rate. When the ECG monitoring system is not functioning under optimal conditions, these currents may appear as artifacts, simulating actual ECG readings. To determine if ECG abnormalities are caused by patient condition or the ECG equipment, place the infusion device on hold. If the ECG readings become normal, the ECG equipment requires attention. Proper setup of the ECG equipment should eliminate these artifacts. Reference the appropriate ECG monitoring system documentation for instructions on setup and maintenance.



Radio Frequency Interference

Operating the system near equipment which radiates high-energy radio frequencies (electrosurgical/cauterizing equipment, portable radios, cellular telephones, etc.) may cause false alarm conditions. If this happens, reposition the infusion device away from the source of interference or turn off the infusion device and manually regulate the flow with the clamp and/or monitor the vital parameters using an appropriate clinical alternative.

Electromagnetic Compatibility (EMC)

When using the Medley™ PCA Module in combination with a Medley™ Point-of-Care Unit which is interconnected to hospital data communications equipment and/or nurse call systems (signal input and signal output ports), the external systems must be certified to applicable standards to ensure correct operation and electromagnetic compliance integrity.

Interconnected data communications systems must be certified to IEC 60950 (data processing equipment) or IEC 60601-1 electromedical equipment. Nurse call systems must be certified to UL 1069 (hospital signaling and nurse call equipment) or comply with the requirements specified in IEC 60601-1.

Compliance with the electromagnetic compatibility standard (IEC 60601-1-2) is a function of all interconnected equipment including cabling and, as such, it is the responsibility of the hospital/facility to ensure external equipment complies with the applicable EMC standards. Failure to verify that external equipment meets applicable EMC standards may result in degraded electromagnetic compatibility (refer to “Radio Frequency Interference” warning for additional information)

WARNING

Use of accessories or cables other than those specified may result in degraded electromagnetic compatibility performance of this device.

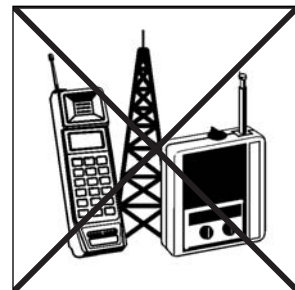

Warnings and Cautions (Continued)

User Precautions (Continued)

Dropping/Jarring

Should an instrument be dropped or severely jarred, it should be immediately taken out of use and inspected by qualified service personnel, to ensure its proper function prior to reuse.

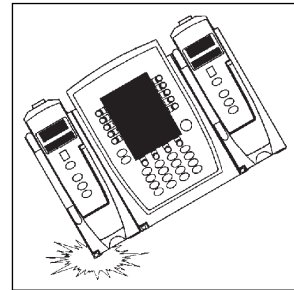

Operating Environment

Not for use in the presence of flammable anesthetics.

◀ DANGER ▶

Explosion risk if used in the presence of flammable anesthetics.



Controls and Indicators

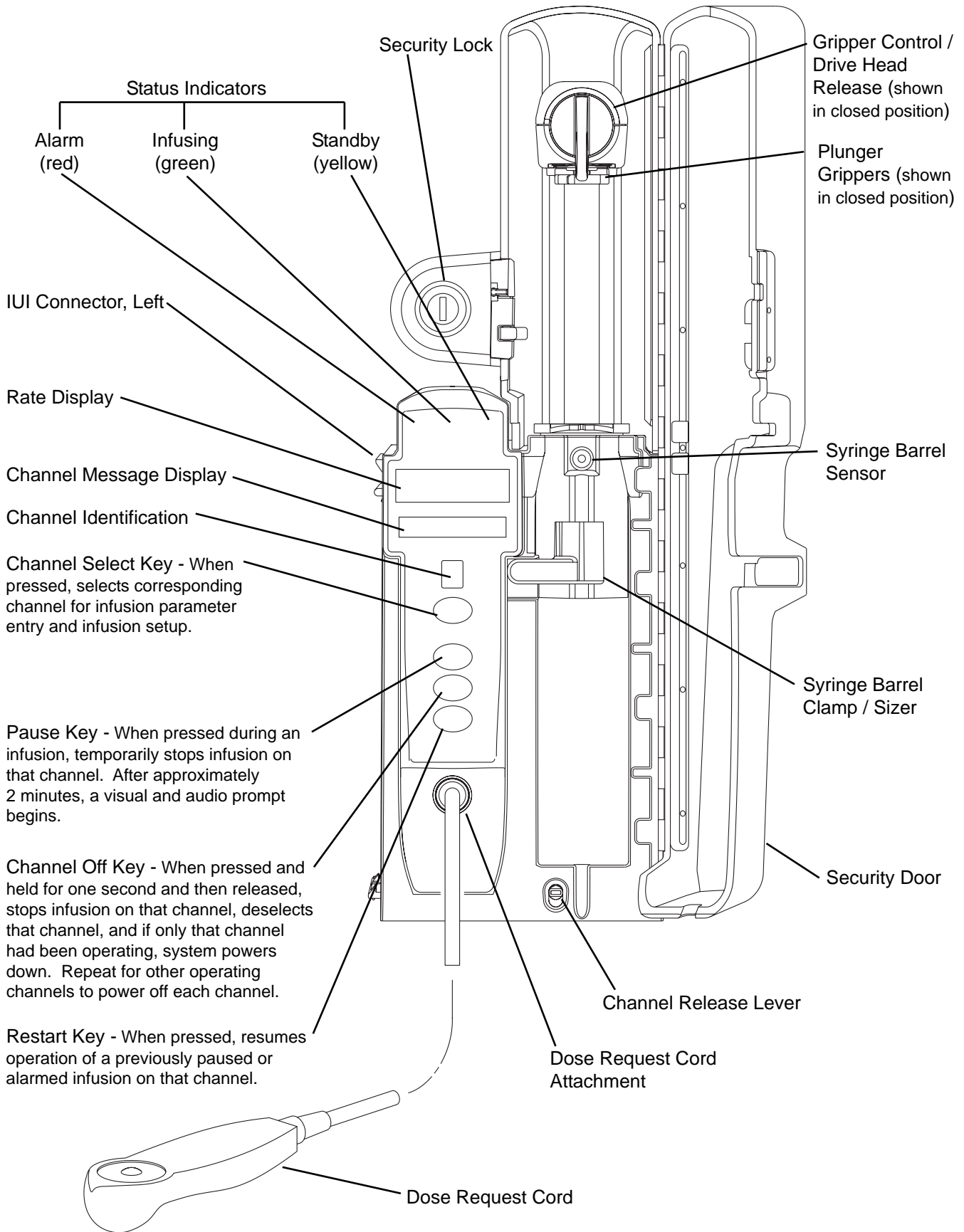

Installation

Instruments are tested and calibrated before they are packaged for shipment. To ensure proper operation after shipment, it is recommended that an incoming inspection be performed before placing the instrument into use.

Unpacking PCA Module

1. Remove the Medley™ PCA Module from its carton.
2. Verify gripper control/drive head release, plunger grippers, and syringe barrel clamp/sizer operate freely and correctly.
3. Verify control surface and instrument housing is not damaged.
4. Check for loose parts.
5. Perform Periodic Inspections (see “Inspection Requirements” section in “Maintenance” chapter).
6. Perform check-in procedure (provided separately; contact ALARIS Medical Systems for further information). If the Medley™ PCA Module fails initial test, it must be removed from service and inspected by qualified personnel.

If the Medley™ PCA Module is damaged, contact ALARIS Medical Systems for authorization to return the instrument for repair.

Attaching and Detaching Channels

Refer to the Medley™ Point-of-Care Unit Directions for Use.

Displays

The displays illustrated throughout this document are for illustration purposes only. The display content will vary, depending on configuration settings, type of disposable in use, hospital-defined data set uploaded using the Guardrails® Safety Software, programmed drug calculation parameters, and many other variables.

Main Display

Refer to the Medley™ Point-of-Care Unit Directions for Use for general information on the Main Display.

Title Bar — Midtown Hospital
Med Surg

Channel Status

- An outlined Channel Letter display indicates channel is attached and ready for use.
- A solid Channel Letter display indicates channel is operating.

Soft Keys — VOLUME INFUSED AUDIO ADJUST

Channel Selected Indicator — A Guardrails Drug Library
Fentanyl

“Active” Soft Key — DRUG AMOUNT — 30 mcg
DILUENT VOLUME — — — — mL

“Inactive” Soft Key — TIME UNITS Hour
DOSING UNITS mcg

Prompt Bar — [Conc]:
>Select DILUENT VOLUME

DRUG LIBRARY

Preparing Syringe and Administration Set

NOTE: Use Aseptic Technique.

1. Prepare syringe (reference “Compatible Syringes” section in “Maintenance” chapter) in accordance with manufacturer’s directions for use.
2. Prepare administration set (reference Set Compatibility Card, provided separately and in this Directions for Use) in accordance with manufacturer’s directions for use.
3. Attach upper fitting of administration set to syringe tip.

WARNING

Use only standard or pre-filled, single-use, disposable syringes (with luer-lock connectors) and non-dedicated administration sets with anti-siphon valves, designed for use on syringe-type PCA devices. The use of incompatible syringe or administration set may cause improper instrument operation, resulting in inaccurate fluid delivery, or other potential hazards. For a list of compatible syringes, refer to the “Compatible Syringes” section in the “Maintenance” chapter. For a list of compatible administration sets, refer to the Set Compatibility Card (provided separately and in this Directions for Use).

Attaching and Detaching Dose Request Cord

The Dose Request Cord must be attached to the PCA Module when delivering a PCA Dose or PCA + Continuous Dose infusion.

To attach the Dose Request Cord:

- Insert latching connector into Dose Request Cord attachment. The red marking on the latching connector should be aligned with the red marking on the Dose Request Cord attachment.

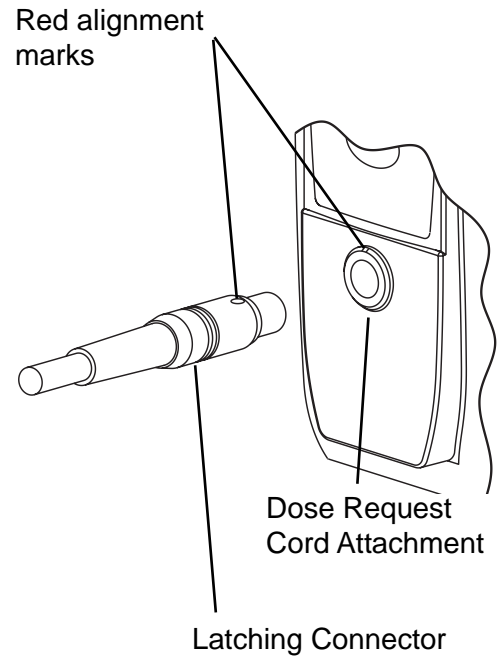

To detach the Dose Request Cord:

- Hold the body of latching connector and pull straight away, without twisting or turning, from the Dose Request Cord attachment.

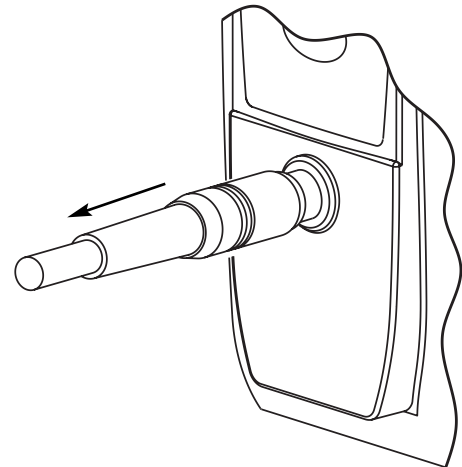

Start-Up

Powering On System

Refer to the Medley™ Point-of-Care Unit Directions for Use.

Responding to Maintenance Reminder

Refer to the Medley™ Point-of-Care Unit Directions for Use.

Choosing Yes or No to New Patient? and Profile?

Refer to the Medley™ Point-of-Care Unit Directions for Use.

Selecting Profile

Refer to the Medley™ Point-of-Care Unit Directions for Use.

Entering Patient ID

Refer to the Medley™ Point-of-Care Unit Directions for Use.

Preparing Infusion

Loading Syringe and Administration Set

1. Open syringe barrel clamp.
 - a. Pull syringe barrel clamp out and hold.
 - b. Rotate clamp to left (clockwise or counter clockwise) until it clears syringe chamber.
 - c. Gently release clamp.

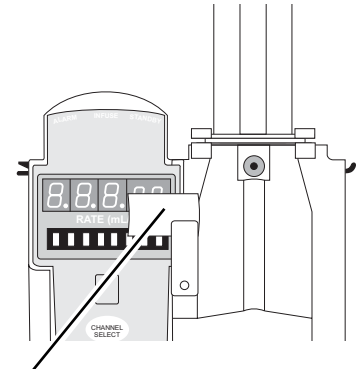

Syringe Barrel Clamp Open

WARNINGS

- Before loading the syringe, check it for damage or defects.
- Ensure syringe barrel, flange, and plunger are installed and secured correctly. Failure to install syringe correctly can result in uncontrolled fluid flow to the patient, and may cause serious injury or death.
- Before loading or unloading the syringe, always turn off fluid flow to the patient, using the tubing clamp or stopcock. Uncontrolled fluid flow can occur when the administration set is not clamped or turned off, and may cause serious injury or death.

CAUTION

When initially loading the syringe, allow for the volume of fluid contained in the administration set and retained in the syringe at the end of an infusion, as this “dead space” will not be infused.

Preparing Infusion (Continued)

Loading Syringe and Administration Set (Continued)

2. Raise drive head to its fully extended position.
 - a. Twist gripper control clockwise and hold in position.

NOTE: The gripper control is spring loaded. When twisted to the open position and then released, it (and the plunger grippers) will return to the closed position.

- b. While holding gripper control in open position, raise drive head to full extension.
 - c. Gently release gripper control.

Drive Head Fully Extended

Gripper Control / Drive Head Release in Open Position

Plunger Grippers Open

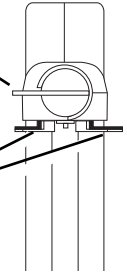

3. Insert syringe (from front of instrument) by sliding flat edge of syringe barrel flange between barrel flange gripper

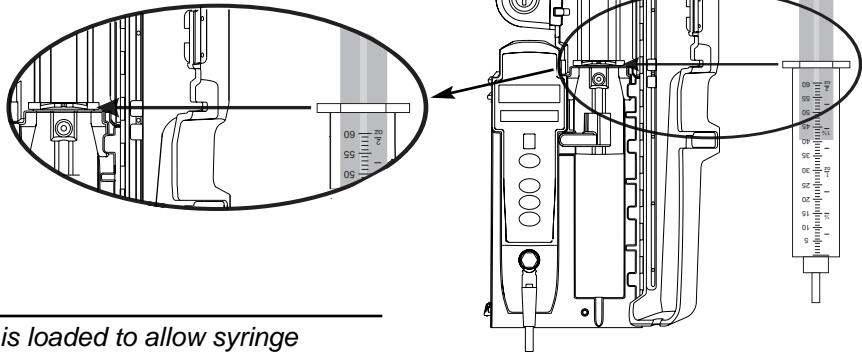

NOTE: Ensure syringe is loaded to allow syringe labeling and gradation marks to face forward for easier viewing.

4. Lock syringe in place.
 - a. Pull syringe barrel clamp out and hold.
 - b. Rotate clamp to right (clockwise or counter clockwise) until it lines up with syringe.
 - c. Gently release clamp against syringe.

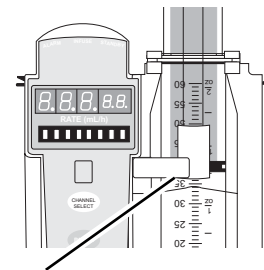

Preparing Infusion (Continued)

Loading Syringe and Administration Set (Continued)

5. Lower drive head and lock plunger in place with plunger grippers.
 - a. Twist gripper control clockwise and hold in position.

NOTE: *The gripper control is spring loaded. When twisted to the open position and then released, it (and the plunger grippers) will return to the closed position.*

- b. While holding gripper control in open position, **gently** lower drive head until it makes contact with plunger flange.
 - c. Gently release gripper control.
 - d. Ensure plunger grippers lock and hold plunger in place.

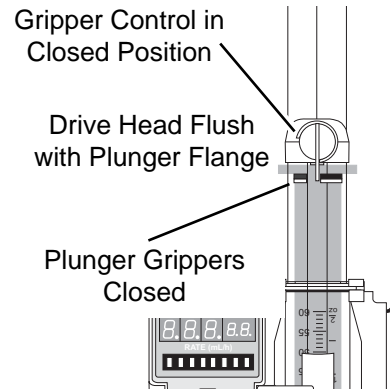

Security Lock Key Positions

There are three key positions associated with the security lock:

- UNLOCK unlocks the security door. The key must be in this position when loading or changing a syringe.
- PROGRAM allows for changes in programming the device without unlocking the security door or interrupting the current infusion.
- LOCK locks the security door. The key must be in this position to start an infusion.

Preparing Infusion (Continued)

Selecting Syringe Type and Size

At the start of an infusion program, the system prompts user to select and confirm the syringe type and size.

NOTE: The system automatically detects the syringe size, and lists syringe types and sizes that most closely match the installed syringe. If the syringe is not recognized, "Syringe not recognized" displays.

WARNING

Ensure the displayed syringe manufacturer and size correctly identifies the installed syringe. Mismatches may cause an under-infusion or over-infusion to the patient that could result in serious injury and/or death. For a list of compatible syringes, refer to the "Compatible Syringes" section in the "Maintenance" chapter. If the installed syringe is displayed and selected, but is not recognized, servicing is required (refer to "Service Information" section in "Maintenance" chapter).

1. Press **CHANNEL SELECT** key. Key must be in **PROGRAM** position.

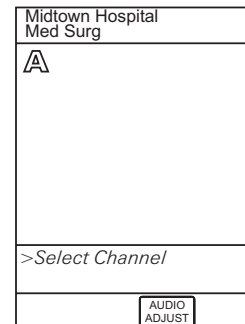

Preparing Infusion (Continued)

Selecting Syringe Type and Size (Continued)

- Press soft key next to installed syringe type and size.
 - Selection is highlighted.

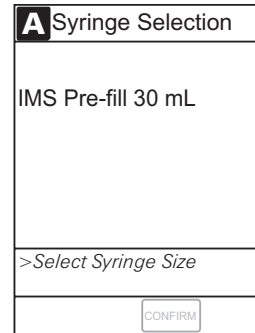

- To accept, press **CONFIRM** soft key.
 - Guardrails® Drug Library screen displays.

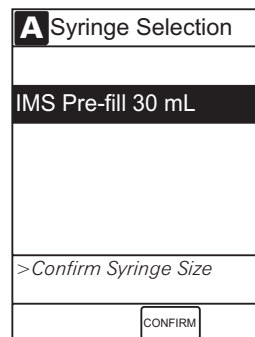

Priming

The Priming option can be enabled at the time the Medley™ System is configured for use. The Priming selection (**PRIME** soft key) is available only after the syringe type and medication selection (prior to infusion mode selection).

WARNING

When priming:

- Ensure patient is not connected.
- Ensure air is expelled from line prior to beginning infusion (unexpelled air in line could have serious consequences).

Failure to prime correctly can delay infusion delivery and cause the total volume to be infused to read higher than the actual total delivered to the patient.

CAUTION

During priming, the pressure limit alarms are temporarily increased to their maximum level.

Preparing Infusion (Continued)

Priming (Continued)

1. Press **OPTIONS** key.
2. Press **Prime Set with Syringe** soft key.

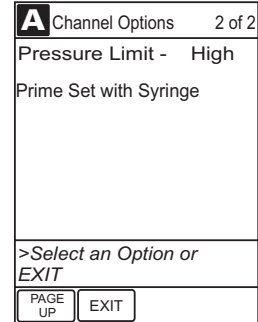

3. Set key to PROGRAM position.

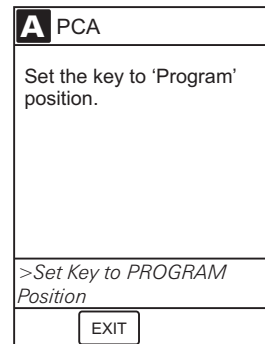

4. Press and hold **PRIME** soft key until fluid flows and priming of syringe administration set is complete.

NOTE: Fluid is delivered during priming only while the **PRIME** soft key is pressed. Each press of the **PRIME** soft key delivers up to 2 mL of priming/fluid per continuous press. To deliver additional amounts, press the **PRIME** soft key again.

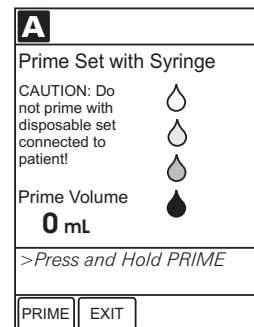

- Volume used during priming is displayed but not added to VTBI.



Preparing Infusion (Continued)

Priming (Continued)

5. When priming is complete, release **PRIME** soft key.
6. To return to main screen, press **EXIT** soft key.
 - Guardrails® Drug Library screen displays.

A	
Prime Set with Syringe	
CAUTION: Do not prime with disposable set connected to patient!	
Prime Volume	
2.1 mL	
>Press and Hold PRIME	
PRIME	EXIT

7. Select Infusion Mode.

A Guardrails Drug Library Morphine	
INFUSION MODE	
PCA Dose only	
Continuous Infusion	
PCA Dose + Continuous	
Loading Dose Only	
>Select an Option or CANCEL	
SETUP	DRUG LIBRARY

Programming An Infusion

The following procedures should be used when programming an infusion.

1. Perform steps in “Preparing Syringe and Administration Set” section.
2. Perform steps in “Start-Up” section, to:
 - a. Power on system.
 - b. Choose **Yes** or **No** to **New Patient?**.

Midtown Hospital	
NEW PATIENT ?	Yes
“Yes” Clears Previous Patient Data	No
>Select Yes or No	
DISPLAY CONTRAST	

Preparing Infusion (Continued)

Programming An Infusion (Continued)

- c. Select profile, if required.
- d. Enter patient identifier, if required.

Midtown Hospital Med Surg	
Med Surg ? "Yes" Confirms Same Profile	Yes
	No
>Select Yes or No	

- 3. Press **CHANNEL SELECT** key.

Midtown Hospital Med Surg	
A	
>Select Channel	
VOLUME INFUSED	AUDIO ADJUST

- 4. Unlock security door or set key to **PROGRAM** position.

A PCA
Set key to 'Program' position.
>Set key to PROGRAM Position
EXIT

- 5. Confirm time of day or change time if necessary.

A PCA	
Time of Day	
Current time: 08:00	Change Time
>CONFIRM Time-of-Day	
EXIT	CONFIRM

Preparing Infusion (Continued)

Programming An Infusion (Continued)

6. Perform steps in “Preparing Infusion” section, to:
 - a. Load syringe and administration set.
 - b. Select and confirm syringe type and size.
 - c. Prime syringe using Prime feature, if desired.

7. Press soft key next to desired drug and concentration.

- Drug/Concentration screen access confirmation appears.

NOTES:

- To view additional drugs/concentrations, press **PAGE UP** and **PAGE DOWN** soft keys.
- The facility may choose to prepopulate standard drug concentrations, or leave an open entry (_ _ / _ _ mL) and allow the clinician to enter the drug amount and diluent volume.

A Guardrails Drug Library Med Surg
Morphine 1 mg/mL
Morphine 5 mg/mL
Meperidine 10 mg/mL
>Select Drug/Concentration
EXIT

Preparing Infusion (Continued)

Programming An Infusion (Continued)

8. Confirm the drug and concentration selection and press **Yes** soft key. To change selection, press **No** soft key.

A Guardrails Drug Library Med Surg	
Morphine 1 mg/mL was selected. Is this correct?	Yes No
>Press Yes or No	

- If **Yes** was selected and facility has defined a Clinical Advisory for that drug, a message appears. To continue programming, press **CONFIRM** soft key.
- If **Yes** was selected to continue programming, drug amount and diluent volume (as defined in Guardrails® Drug Library) are automatically entered for selected drug.
- If selected drug had “__ / __ mL” concentration, drug amount and diluent volume will need to be entered.

NOTES:

- *If the programmed “__ / __ mL” concentration is outside the Guardrails® Soft Limit, a prompt appears before programming can continue. If the YES soft key is pressed, programming continues; if the NO soft key is pressed, the infusion must be reprogrammed.*
- *If the programmed “__ / __ mL” concentration is outside the Guardrails® Hard Limit for that care area, a prompt appears before programming can continue. The drug amount and diluent volume must be reprogrammed.*

9. Verify parameters are correct and press **NEXT** soft key to confirm.

A Guardrails Drug Library Morphine	
DRUG AMOUNT	30 mg
DILUENT VOLUME	30 mL
TIME UNITS	Hour
DOSING UNITS	mg
[Conc]: 1 mg/mL	
>Press NEXT to Confirm	
	DRUG LIBRARY NEXT

PCA Infusion Modes

PCA Module Programming Parameters

The Medley™ PCA Module uses the following programming parameters, depending on infusion mode selected. Refer to the Features and Definitions of this Directions for Use for the definitions and features of the infusion modes.

- **PCA Dose:** patient self-administered dose.
- **Lockout Interval:** programmed time elapse between availability of PCA doses.
- **Continuous Dose:** basal rate dose.
- **Max Limit:** (optional) total amount of drug which can be infused over a specified time period.
- **Loading Dose:** (optional) bolus dose infused prior to initiation of PCA infusion.
- **Bolus Dose:** (optional) additional dose programmed after the initiation of PCA infusion.

NOTE: When the Medley™ Point-of-Care Unit is in the Infusion Mode Selection, Infusion Setup or Bolus Setup screens, a patient dose request from the dose request cord will be handled as an unmet demand.

Setting Up PCA Dose Only

The following procedures should be used when programming a PCA Dose Only infusion.

1. Perform steps in “Preparing Infusion” section of this Directions for Use.
2. Press **PCA Dose Only** soft key from Infusion Mode screen.

A Guardrails Drug Library Morphine
INFUSION MODE
PCA Dose only
Continuous Infusion
PCA Dose + Continuous
Loading Dose Only
>Select an Option or CANCEL
SETUP DRUG LIBRARY

PCA Infusion Modes (Continued)

Setting Up PCA Dose Only (Continued)

3. To enter PCA Dose, use numeric data entry keys.

A PCA Only Morphine	
PCA DOSE	20 mg
LOCKOUT INTERVAL	___ minutes
MAX LIMIT	None
LOADING DOSE	None
[Conc]: 1 mg/mL	
>Select LOCKOUT INTERVAL	
CHANGE MODE	

4. To enter Lockout Interval, press **LOCKOUT INTERVAL** soft key and use numeric data entry keys.

A PCA Only Morphine	
PCA DOSE	20 mg
LOCKOUT INTERVAL	10 minutes
MAX LIMIT	None
LOADING DOSE	None
[Conc]: 1 mg/mL	
>Close and Lock Door Then Press CONFIRM	
CHANGE MODE	CONFIRM

5. To enter Max Limit, press **MAX LIMIT** soft key, press **YES** soft key and use numeric data entry keys.

NOTE: Time (in hours) associated with Max Limit will automatically be entered based on set-up in system configuration.

6. To enter Loading Dose, press **LOAD DOSE** soft key, press **YES** soft key and use numeric data entry keys.

NOTE: Loading Dose is included in VTBI but is not included in MAX LIMIT.

A Guardrails Drug Library IMS Pre-fill 30mL	
PCA DOSE	2 mg
LOCKOUT INTERVAL	10 minutes
MAX LIMIT	___ mg/4 h
LOADING DOSE	None
[Conc]: 1 mg/mL	
>Enter Max Limit	
CHANGE MODE	

PCA Infusion Modes (Continued)

Setting Up PCA Dose Only (Continued)

7. Verify parameters are correct and press **CONFIRM** soft key.

*NOTES: If the programmed PCA Dose, Lockout Interval, Max Limit or Loading Dose are outside the Guardrails® Soft Limit, a prompt appears before programming can continue. If the **Yes** soft key is pressed, programming continues; if the **No** soft key is pressed, the infusion must be reprogrammed.*

*If the programmed PCA Dose, Lockout Interval, Max Limit or Loading Dose are outside the Guardrails® Hard Limit for that care area, a prompt appears before programming can continue. The infusion must be **reprogrammed**.*

A PCA Only Morphine	
PCA DOSE	2 mg
LOCKOUT INTERVAL	10 minutes
MAX LIMIT	25 mg/4 h
LOADING DOSE	None
[Conc]: 1 mg/mL	
>Close and Lock Door Then Press CONFIRM	
CHANGE MODE	CONFIRM

8. Close and lock security door.

A PCA
Close and lock the door.
>Close and Lock Door
EXIT

9. Verify parameters on second nurse summary screen are correct and press **START** key.

- Infusion mode and PCA drug name scroll in Channel Message Display.
- Main Display alternates between Volume Remaining and PCA drug name with infusion mode.
- When PCA dose is delivered:
 - ◆ Green Infusing Status Indicator illuminates.
 - ◆ Rate display flashes “_ _ _ _ _”.
 - ◆ **DELIVERING PCA** scrolls in channel message display.
 - ◆ When PCA Dose is complete, **PCA COMPLETE** scrolls in Channel Message Display.

A Second Nurse Summary Morphine		
PCA Dose:	2 mg	
Lockout Interval:	10 minutes	
Max Limit:	25 mg/4 h	
[Conc]: 1 mg/mL		
>Press START		
PAUSE	PRO-GRAM	START

PCA Infusion Modes (Continued)

Setting Up Continuous Infusion Only

The following procedures should be used when programming a Continuous Infusion Only infusion.

1. Perform steps in “Preparing Infusion” section of this Directions for Use.
2. Press **CONTINUOUS INFUSION** soft key from Infusion Mode screen.

A Guardrails Drug Library Morphine
INFUSION MODE
PCA Dose only
Continuous Infusion
PCA Dose + Continuous
Loading Dose Only
>Select an Option
<input type="button" value="SETUP"/> <input type="button" value="DRUG LIBRARY"/>

3. To enter continuous infusion dose, press **CONT DOSE** soft key and use numeric data entry keys.

A Continuous Morphine
<input type="button" value="CONT DOSE"/> _ _ _ mg/h <input type="button" value="MAX LIMIT"/> None <input type="button" value="LOADING DOSE"/> None [Conc]: 1 mg/mL >Enter Continuous Dose
<input type="button" value="CHANGE MODE"/>

4. To enter Max Limit, press **MAX LIMIT** soft key, press **YES** soft key and use numeric data entry keys.

NOTE: Time (in hours) associated with Max Limit will automatically be entered based on set-up in system configuration.

A Continuous Morphine
<input type="button" value="CONT DOSE"/> 2 mg/h <input type="button" value="Yes"/> <input type="button" value="MAX LIMIT"/> >>>> <input type="button" value="No"/> <input type="button" value="LOADING DOSE"/> None [Conc]: 1 mg/mL >Select Max Limit Option
<input type="button" value="CHANGE MODE"/>

PCA Infusion Modes (Continued)

Setting Up Continuous Infusion Only (Continued)

5. To enter Loading Dose, press **LOAD DOSE** soft key, press **YES** soft key and use numeric data entry keys.

NOTE: Loading Dose is included in the VTBI but is not included in the MAX LIMIT.

A Continuous Morphine	
CONT DOSE	2 mg/h
MAX LIMIT	30 mg/4 Yes
LOADING DOSE	>>>> No
[Conc]: 1 mg/mL	
>Select Loading Dose Option	
CHANGE MODE	

6. Verify parameters are correct and press **CONFIRM** soft key.

*NOTES: If the programmed Continuous Dose, Max Limit or Loading Dose are outside the Guardrails® Soft Limit for that care area, a prompt appears before programming can continue. If the **Yes** soft key is pressed, programming continues; if the **No** soft key is pressed, the infusion needs to be reprogrammed.*

*If the programmed Continuous Dose, Max Limit or Loading Dose are outside the Guardrails® Hard Limit for that care area, a prompt appears before programming can continue. The infusion needs to be **reprogrammed**.*

A Continuous Morphine	
CONT DOSE	2 mg/h
MAX LIMIT	30 mg/4 h
LOADING DOSE	_ _ 1 mg
[Conc]: 1 mg/mL	
>Press CONFIRM	
CHANGE MODE	CONFIRM

7. Close and lock security door.

8. Verify programming parameters are correct and press **START** key.

- Green Infusing Status Indicator illuminates.
- Infusion mode and drug name scroll in Channel Message Display. If a Loading Dose has been entered, scrolls **DELIVERING LOAD**.
- Volume Infused in mL/h in Rate Display
- Main Display alternates between volume remaining and Infusion mode with drug name.

A Second Nurse Summary Morphine		
Cont. Dose:	2 mg/h	
Max Limit:	30 mg/4 h	
Loading Dose:	1 mg	
[Conc]: 1 mg/mL		
>Press START		
PAUSE	PRO-GRAM	START

PCA Infusion Modes (Continued)

Setting Up PCA Dose + Continuous Infusion

The following procedures should be used when programming a PCA Dose + Continuous Infusion.

1. Perform steps in “Preparing Infusion” section of this Directions for Use.
2. Press **PCA DOSE + CONTINUOUS** soft key from Infusion Mode screen.

A	Guardrails Drug Library Morphine
INFUSION MODE	
PCA Dose only	
Continuous Infusion	
PCA Dose + Continuous	
Loading Dose Only	
>Select an Option or CANCEL	
SETUP	DRUG LIBRARY

3. To enter PCA Dose, press **PCA DOSE** soft key and use numeric data entry keys.

A	PCA + Continuous Morphine
PCA DOSE	1 mg
LOCKOUT INTERVAL	___ minutes
CONT DOSE	___ mg/h
MAX LIMIT	None
LOADING DOSE	None
[Conc]: 1 mg/mL	
>Enter Lockout Interval	
CHANGE MODE	

4. To enter Lockout Interval, press **LOCKOUT INTERVAL** soft key and use numeric data entry keys.

A	Guardrails Drug Library IMS Pre-fill 30mL
PCA DOSE	1 mg
LOCKOUT INTERVAL	10 minutes
CONT DOSE	___ mg/h
MAX LIMIT	None
LOADING DOSE	None
[Conc]: 1 mg/mL	
>Select CONT DOSE	
CHANGE MODE	

PCA Infusion Modes (Continued)

Setting Up PCA Dose + Continuous Infusion (Continued)

- To enter Continuous Dose, press **CONT DOSE** soft key, press and use numeric data entry keys.

A Guardrails Drug Library IMS Pre-fill 30mL	
PCA DOSE	1 mg
LOCKOUT INTERVAL	10 minutes
CONT DOSE	2 mg/h
MAX LIMIT	None
LOADING DOSE	None
[Conc]: 1 mg/mL	
>Dose 20 Will Exceed Max Flow Rate	
CHANGE MODE	

- To enter Max Limit, press **MAX LIMIT** soft key, press **YES** soft key and use numeric data entry keys.

NOTES: Time (in hours) associated with Max Limit will automatically be entered based on set-up in system configuration.

- To enter Loading Dose, press **LOAD DOSE** soft key, press **YES** soft key and use numeric data entry keys.

NOTE: Loading Dose is included in the VTBI but is not included in the MAX LIMIT.

A Guardrails Drug Library IMS Pre-fill 30mL	
PCA DOSE	1 mg
LOCKOUT INTERVAL	10 minutes
CONT DOSE	2 mg/h
MAX LIMIT	8 mg/4 h
LOADING DOSE	None
[Conc]: 1 mg/mL	
>Close and lock door then Press CONFIRM	
CHANGE MODE	CONFIRM

- Verify parameters are correct and press **CONFIRM** soft key.

*NOTES: If the programmed PCA Dose, Lockout Interval, Continuous Dose, Max Limit or Loading Dose are outside the Guardrails® Soft Limit for that care area, a prompt appears before programming can continue. If the **Yes** soft key is pressed, programming continues; if the **No** soft key is pressed, the infusion needs to be reprogrammed.*

*If the programmed PCA Dose, Lockout Interval, Continuous Dose, Max Limit or Loading Dose are outside the Guardrails® Hard Limit for that care area, a prompt appears before programming can continue. The infusion needs to be **reprogrammed**.*

- Close and lock security door.

A Guardrails Drug Library IMS Pre-fill 30mL	
PCA DOSE	1 mg
LOCKOUT INTERVAL	10 minutes
CONT DOSE	2 mg/h
MAX LIMIT	8 mg/4 h
LOADING DOSE	None
[Conc]: 1 mg/mL	
>Press CONFIRM	
CHANGE MODE	CONFIRM

PCA Infusion Modes (Continued)

Setting Up PCA Dose + Continuous Infusion (Continued)

10. Verify parameters on second nurse summary screen are correct and press **START** key.

- During PCA Dose + Continuous Infusion:
 - ◆ Green Infusing Status Indicator illuminates.
 - ◆ DELIVERING PCA scrolls in Channel Message Display when initiated. Continuous and PCA drug name scrolls in Channel Message Display between PCA doses.
 - ◆ Volume infused for continuous dose is displayed in ml/h in Rate Display.
 - ◆ Main Display alternates between volume remaining and Infusion mode with PCA drug name.
 - ◆ When PCA Dose is complete, **PCA COMPLETE** scrolls in Channel Message Display and resumes Continuous dose.

A	Second Nurse Summary Morphine	
PCA Dose:	1 mg	
Lockout Interval:	10 minutes	
Cont. Dose:	2 mg/h	
Max Limit:	8 mg/4 h	
[Conc]: 1 mg/mL		
> Press START		
PAUSE	PRO-GRAM	START

PCA Infusion Modes (Continued)

Setting Loading Dose Only

The following procedures should be used when setting a Loading Dose Only using the Guardrails® Drug Library.

Setting Loading Dose from Infusion Mode Screen

1. Perform steps in “Preparing Infusion” section of this Directions for Use.
2. Press **LOADING DOSE ONLY** soft key from Infusion Mode screen.

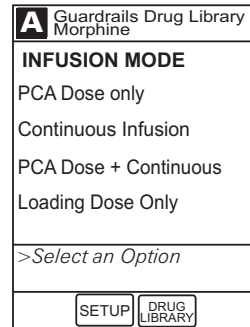

A Guardrails Drug Library
Morphine

INFUSION MODE

PCA Dose only
Continuous Infusion
PCA Dose + Continuous
Loading Dose Only

>Select an Option

SETUP DRUG LIBRARY

3. Use numeric data entry keys to enter dose value.
4. Verify dose value is correct and then press **CONFIRM** soft key.

NOTES: Loading dose is included in the VTBI but is not included in the Max Limit.

*If the programmed Loading Dose is outside the Guardrails® Soft Limit for that care area, a prompt appears before programming can continue. If the **Yes** soft key is pressed, programming continues; if the **No** soft key is pressed, the infusion needs to be reprogrammed.*

*If the programmed Loading Dose is outside the Guardrails® Hard Limit for that care area, a prompt appears before programming can continue. The infusion needs to be **reprogrammed**.*

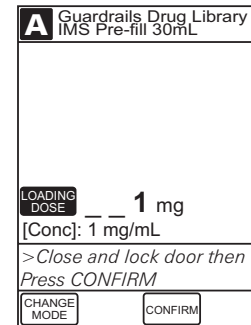

A Guardrails Drug Library
IMS Pre-fill 30mL

LOADING DOSE _ _ 1 mg
[Conc]: 1 mg/mL

>Close and lock door then Press CONFIRM

CHANGE MODE CONFIRM

5. Close and lock security door.

PCA Infusion Modes (Continued)

Setting Loading Dose (Continued)

Setting Loading Dose from Infusion Mode Screen (Continued)

6. Verify parameters on summary screen are correct and press **START** key.
 - **DELIVERING LOAD** scrolls in Channel Message Display.
 - Infusion mode and Drug name appear in Main Display.
 - When Loading Dose is complete, **The Loading Dose has Completed** appears on Main Display.

A	Second Nurse Summary Morphine	
Loading Dose: 1 mg [Conc]: 1 mg/mL		
>Press START		
PAUSE	PRO-GRAM	START

-
7. Press **CONFIRM**.

- Upon pressing Channel Select on PCA Module, Infusion Mode screen becomes available for selection of Infusion Mode.

A
The loading dose has completed.
>Press CONFIRM
CONFIRM

PCA Infusion Modes (Continued)

Setting Bolus Dose

The following procedures should be used only when setting a Bolus Dose using the Guardrails® Drug Library.

NOTES: The **BOLUS DOSE** soft key is only available once an infusion has begun in PCA Dose Only, Continuous Infusion, or PCA + Continuous Infusion Modes.

1. Press **CHANNEL SELECT** on PCA Module.
2. Press **BOLUS DOSE** soft key.

A Summary Morphine
Cont. Dose 2 mg/h Max Limit: 30 mg/4 h
[Conc]: 1 mg/mL
>Press START to Close Summary
PRO-GRAM BOLUS DOSE START

3. Set key to **PROGRAM** position or enter 4 digit authorization code and press **CONFIRM**.

A PCA
Set key to 'Program' position or enter authorization code:

>Set Key to PROGRAM position or enter code
CONFIRM

4. Use numeric data entry keys to enter dose value.
5. Press **CONFIRM**.

NOTES: If the programmed Bolus Dose is outside the Guardrails® Soft Limit for that care area, a prompt appears before programming can continue. If the **Yes** soft key is pressed, programming continues; if the **No** soft key is pressed, the infusion needs to be reprogrammed.

If the programmed Bolus Dose is outside the Guardrails® Hard Limit for that care area, a prompt appears before programming can continue. The infusion needs to be **reprogrammed**.

A Morphine
BOLUS DOSE
DOSE _ _ _ _ mg
[Conc]: 1 mg/mL
>Enter BOLUS Dose

PCA Infusion Modes (Continued)

Setting Bolus Dose (Continued)

6. If Authorization Code is disabled, door must be locked prior to starting Bolus Dose.
7. Verify dose value is correct and then press **START** soft key:
 - **Delivering Bolus** scrolls in Channel Message Display
 - Bolus and drug name appears in Main Display
 - When Bolus Dose is complete, **BOLUS COMPLETE** scrolls in Channel Message Display.
 - Programmed infusion resumes.

A	Guardrails Drug Library IMS Pre-fill 30mL		
Cont. Dose:	2 mg/h		
Max Limit:	30 mg/4 h		
Bolus Dose:	1 mg		
[Conc]:	1 mg/mL		
>Press START			
PAUSE	PRO-GRAM	BOLUS DOSE	START

Stopping a Loading, PCA or Bolus Dose

The following procedure should be used to stop a Loading, PCA or Bolus Dose.

1. Press **CHANNEL SELECT** key on PCA Module.
2. Press **STOP LOAD, STOP PCA or STOP BOLUS** soft key as applicable.

NOTE: Soft key will reflect the type of dose that is currently infusing.

3. To stop dose and resume current program, press **YES** soft key.

PCA Infusion Modes (Continued)

Changing Programming Parameters During an Infusion

The following procedures should be used only when changing programming parameters during an infusion.

1. Press **CHANNEL SELECT** key.

Midtown Hospital Med Surg	
A PCA + Cont Morphine	
VOLUME INFUSED	AUDIO ADJUST

2. Press **PROGRAM** soft key.

A Summary Morphine		
PCA Dose: 2 mg		
Lockout Interval: 20 minutes		
Cont. Dose: 2 mg/h		
Max Limit: 25 mg/4 h		
[Conc]: 1 mg/mL		
>Press <i>START</i>		
PRO- GRAM	BOLUS DOSE	START

3. Set key to program position or if Authorization Code is enabled, enter 4 digit code.

A PCA
Set key to 'Program' position.
>Set Key to <i>PROGRAM</i> <i>Position</i>
EXIT

PCA Infusion Modes (Continued)

Changing Programming Parameters During an Infusion (Continued)

- Press **CHANGE MODES** softkey.

A Guardrails Drug Library IMS Pre-fill 30mL	
PCA DOSE	2 mg
LOCKOUT INTERVAL	20 minutes
CONT DOSE	2 mg/h
MAX LIMIT	25 mg/4 h
[Conc]: 1 mg/mL	
>Close and lock door then Press CONFIRM	
CHANGE MODES	CONFIRM

- Select desired Infusion Mode.

A Guardrails Drug Library Morphine	
INFUSION MODE	
PCA Dose only	
Continuous Infusion	
PCA Dose + Continuous	
> Select an Option or Cancel	
SETUP	

- Continue programming as outlined in Setting Up PCA Dose Only, PCA + Continuous Infusion or Continuous Infusion Only sections.

NOTE: Previously programmed values are carried over to new program.

- Verify or change program settings and press **CONFIRM** key.
- Close and lock door.

A Guardrails Drug Library Morphine			
PCA Dose:	2 mg		
Lockout Interval:	20 minutes		
Max Limit:	25 mg/4 h		
[Conc]: 1 mg/mL			
>Press START			
PAUSE	PRO-GRAM	BOLUS DOSE	START

PCA Infusion Modes (Continued)

Changing Programming Parameters During an Infusion (Continued)

9. Verify programming parameters on summary screen are correct and press **START** key.

A Second Nurse Summary Morphine
PCA Dose: 2 mg
Lockout Interval: 20 minutes
Max Limit: 25 mg/4 h
[Conc]: 1 mg/mL
>Press <i>START</i>
PAUSE PRO-GRAM BOLUS DOSE START

Viewing Patient History

The following procedures should be used to view patient history.

1. Press **CHANNEL SELECT** key.

Midtown Hospital Med Surg
A Cont Morphine
VOLUME INFUSED AUDIO ADJUST

2. From Main Display, press **OPTIONS** key.

A Summary Morphine
Cont. Dose: 2 mg/h
Max Limit: 25 mg/4 h
[Conc]: 1 mg/mL
>Press <i>START</i> to Close <i>Summary</i>
PRO-GRAM BOLUS DOSE START

PCA Infusion Modes (Continued)

Viewing Patient History (Continued)

- Press **Patient History** soft key.

A Channel Options 1 of 2
PCA Guardrails Setup
Infusion Modes
Patient History
Dose Request Setup
Drug Event History
>Select an Option or EXIT
EXIT PAGE DOWN

- Press **ZOOM** soft key to select desired time period.

- Patient History contains:
 - Total Drug Delivered.
 - Total Demands.
 - Delivered (demands).

NOTE: Total Drug Delivered includes applicable Loading Dose, PCA Dose, Continuous Dose, and Bolus Dose. Total Drug Delivered does not include priming volume.

A Patient History 09:01
History from 07:01 - 09:01
LAST CLEARED 07:00 2003-6-10
SHIFT TOTALS
Total Drug: 22 mg
Total Demands: 5
Delivered: 2
ZOOM: 24 12 8 4 2 1 hours
>Press ZOOM to Change Time Scale
CLEAR HISTORY ZOOM EXIT DETAIL

- Press **DETAIL** soft key to view Detailed Patient History.

- Detailed Patient History contains:
 - Total Drug Delivered.
 - Total Drug Delivered via:
 - PCA Dose.
 - Continuous Infusion.
 - Loading Dose.
 - Bolus Dose.
 - Average Drug Per Hour.

A Morphine 1mg/mL
History from 07:01 - 09:01
Total Drug: 22 mg
PCA Dose: 14 mg
Continuous Infusion: 4 mg
Loading Dose: 2 mg
Bolus Dose: 2 mg
Average Drug per Hr: 11 mg
ZOOM: 24 12 8 4 2 1 hours
>Press ZOOM to Change Time Scale
ZOOM EXIT MAIN HISTORY

- To return to Main Patient History, press **MAIN HISTORY** soft key.

A Patient History 09:01
History from 07:01 - 09:01
LAST CLEARED 07:00 2003-6-10
SHIFT TOTALS
Total Drug: 22 mg
Total Demands: 5
Delivered: 2
ZOOM: 24 12 8 4 2 1 hours
>Press ZOOM to Change Time Scale
CLEAR HISTORY ZOOM EXIT DETAIL

PCA Infusion Modes (Continued)

Viewing Patient History (Continued)

- To return to Main Display, press **EXIT** soft key.

NOTE: The Patient History stores a rolling 24 hour log. Patient history is automatically cleared upon selection of "**New Patient?**", "**Yes**", in "**Start Up**" Section, or upon changing drug selection in Guardrails® Drug Library.

A Summary Morphine	
Cont. Dose:	2 mg/h
Max Limit:	25 mg/4 h
[Conc]: 1 mg/mL	
>Press START to Close	
Summary	
PRO-GRAM	BOLUS DOSE START

Clearing Patient History

The following procedures should be used to clear patient history.

- Press **CLEAR HISTORY** soft key.
A confirmation screen appears.

A Patient History 09:01	
History from 07:01 - 09:01	
LAST CLEARED	07:00 2003-6-10
SHIFT TOTALS	
Total Drug:	22 mg
Total Demands:	5
Delivered:	2
ZOOM: 24 12 8 4 2 1 hours	
>Press ZOOM to Change	
Time Scale	
CLEAR HISTORY	ZOOM EXIT DETAIL

- To continue and clear patient history, press **YES** soft key.
To cancel and return to patient history, press **NO** soft key.

A PCA	
Are you sure you would like to clear the Patient History?	Yes No
>Press Yes or No	

PCA Infusion Modes (Continued)

Clearing Patient History (Continued)

- Once patient history is cleared, the last 24 hours of patient history data may be retrieved and viewed.
Select **24 h Totals** soft key from Patient History screen to retrieve the last 24 hours.

A	Morphine 1mg/mL		
History from 07:01 - 09:01			
LAST CLEARED	09:01 2003-6-10		
SHIFT TOTALS			
Total Drug:	0 mg		
Total Demands:	0		
Delivered:	0		
	24 h Totals		
ZOOM: 24 12 8 4 2 1 hours			
>Press ZOOM to Change Time Scale			
CLEAR HISTORY	ZOOM	EXIT	DETAIL

- Press **SHIFT TOTALS** soft key to return to Patient History view.

NOTE: The 24 h Totals soft key appears only if the shift total is cleared and additional patient history information exists (up to the previous 24 hours).

A	Morphine 1mg/mL	
History from 07:01 - 09:01		
LAST CLEARED	09:01 2003-6-10	
24 h TOTALS		
Total Drug:	22 mg	
Total Demands:	5	
Delivered:	2	
	Shift Totals	
ZOOM: 24 12 8 4 2 1 hours		
>Press ZOOM to Change Time Scale		
	ZOOM	EXIT

PCA Infusion Modes (Continued)

Viewing Drug Event History

The following procedures should be used to view detailed drug event history.

1. Press **CHANNEL SELECT** key.

Midtown Hospital Med Surg	
A Cont Morphine	
VOLUME INFUSED	AUDIO ADJUST

2. From Main Display, press **OPTIONS** key.

A Summary Morphine		
Cont. Dose: 2 mg/h		
Max Limit: 25 mg/4 h		
[Conc]: 1 mg/mL		
>Press START		
PRO- GRAM	BOLUS DOSE	START

3. Press **Drug Event History** soft key.

A Channel Options 1 of 2	
PCA Guardrails Setup	
Infusion Modes	
Patient History	
Dose Request Setup	
Drug Event History	
>Select an Option or EXIT	
EXIT	PAGE DOWN

4. Press **PAGE DOWN** soft key to scroll through history.

A Drug Event History 1	
2003-06-10	DRUG EVENT
TIME	Morphine (1mg/mL)
09:01	PCA Dose, 1 mg
08:38	Unmet demands - 5
07:08	Continuous, 2 mg/h
07:08	PCA + Cont infusion
08:08	New syringe
06:10	Bolus Dose stopped
06:08	Bolus Dose, 1mg
06:00	History cleared
>Press PAGE DOWN or PAGE UP to View Events	
EXIT	PAGE DOWN

5. To return to Main Display, press **EXIT** soft key.

NOTE: The **Drug Event History** stores approximately 12 hours of events. Drug Event History is automatically cleared upon selection of "New Patient?", "Yes", in "Start-Up" section.

PCA Infusion Modes (Continued)

Configuring Dose Request Cord

The Dose Request Cord can be configured to provide both audio and visual prompts to the patient. Visual prompts are provided through the LED indicator on the Dose Request Cord.

Default configuration for the Dose Request Cord is established in the system configuration.

To change the Dose Request Cord configuration:

1. Press **CHANNEL SELECT** key.

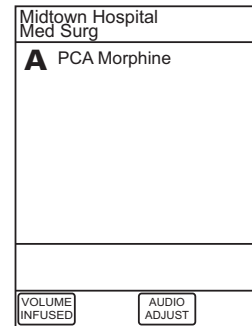

2. From Main Display, press **OPTIONS** key.

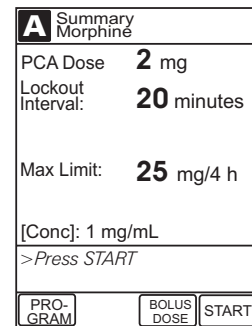

3. Press **Dose Request Setup** soft key.

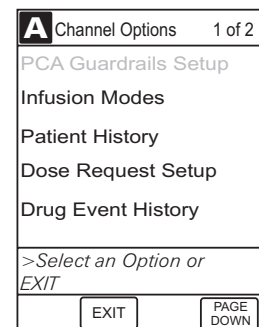

PCA Infusion Modes (Continued)

Configuring the Dose Request Cord (Continued)

- Review and select the **Profile** soft key for the desired operation of the dose request cord.

A Dose Request Setup	
Select the desired functional profile for the operation of the Dose Request Cord.	Profile 1
	Profile 2
	Profile 3
Profile 1 -	
Audio: good demands	
Visual: PCA available	ON
PCA delivery	FLASHES
Lockout interval	OFF
>Select an Option	
CONFIRM	

	PROFILE 1	PROFILE 2	PROFILE 3
Dose Request Cord Audio - Single Beep	Met demands only	All Demands	All Demands
Dose Request Cord LED Indicator:			
PCA Available	ON	ON	OFF
PCA Delivery	"ON-FLASHING"	ON	OFF
Lockout Interval	OFF	ON	OFF

- Press **CONFIRM** soft key.

PCA Infusion Modes (Continued)

Security Access Levels

The security access level can be configured to provide varying levels of access to the device. Security access is accomplished either through the use of the key or a four-digit authorization code.

Default configuration for the security access level is established for each profile or care area and can be changed in the system configuration. The four-digit authorization code is established and can be changed in the system configuration.

The four-digit authorization code is the same for all profiles with Level 2 or Level 3 security access.

Security Access Level	Initial Programming	Setting Bolus Dose	Subsequent Programming
Level 1	Key	Key	Key
Level 2	Key	Code or Key	Key
Level 3	Key	Code or Key	Code or Key

The security code may be disabled for a specific infusion by using the following procedure:

1. Press **CHANNEL SELECT** key.
2. From Main Display, press **OPTIONS** key.
3. Press **Security Code Access** soft key.

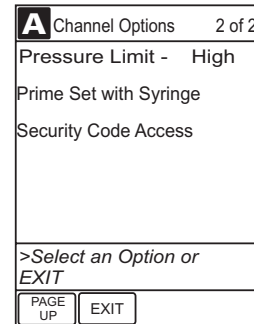

4. Press **DISABLE CODE** soft key.
5. Press **CONFIRM** soft key.

The security access code will remain disabled until "**New Patient? ► Yes**" is selected in the Start-Up of an infusion or if the unit remains powered off for more than eight hours.

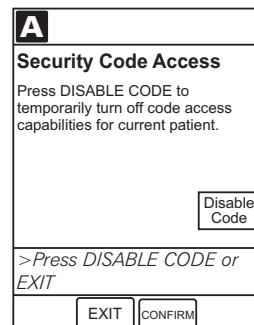

PCA Infusion Modes (Continued)

Pausing Infusion

1. Press **PAUSE** key on PCA Module.

OR

From Second Nurse Summary screen, press **PAUSE** soft key.

- **PAUSE** scrolls in Channel Message Display.
- **PAUSED** appears on Main Display.
- Yellow Standby Status Indicator illuminates.
- After two minutes, “**PAUSE-RESTART CHANNEL**” visual and audio prompts begin, and yellow Standby Status Indicator flashes.

A	Second Nurse Summary Morphine		
PCA Dose:	2 mg		
Lockout Interval:	20 minutes		
Cont. Dose:	2 mg/h		
Max Limit:	20 mg/4 h		
[Conc]: 1 mg/mL			
>Press <i>START</i>			
PAUSE	PRO-GRAM	BOLUS DOSE	START

2. To reinitiate infusion:

- Press **RESTART** key on PCA Module.

OR

- Press **CHANNEL SELECT** key and then press **START** soft key on Main Display.

A	Second Nurse Summary Morphine		
PCA Dose:	2 mg		
Lockout Interval:	20 minutes		
Cont. Dose:	2 mg/h		
Max Limit:	20 mg/4 h		
[Conc]: 1 mg/mL			
>Press <i>START</i>			
PAUSE	PRO-GRAM	BOLUS DOSE	START

PCA Infusion Modes (Continued)

Restoring Infusion Following Syringe Empty

1. If syringe requires replacement:
 - a. Unlock security door.
 - b. Remove existing syringe and prepare new syringe (reference “Preparing Syringe and Administration Set” section).
 - c. Load syringe and administration set (reference “Preparing Infusion” section).
 - d. Select syringe type and size (reference “Preparing Infusion” section).
 - e. Prime (reference “Preparing Infusion” section).

2. To restart infusion using restored parameters, press **RESTORE** soft key and continue with next step.

OR

To start a new infusion, select drug from the Guardrails® Drug Library and follow steps for PCA Infusion Modes.

A Guardrails Drug Library Med Surg
Morphine 1 mg/mL
Morphine 5 mg/mL
Meperidine 10 mg/mL
>Select Drug/Concentration or Restore Previous Infusion
EXIT RESTORE

3. For restored parameters, verify parameters are valid and press **CONFIRM** soft key.

NOTE: To change a restored parameter:

- a. Press applicable soft key.
- b. Enter desired parameter using numeric data entry keys.
- c. Press **CONFIRM** soft key.

A Guardrails Drug Library IMS Pre-fill 30mL
PCA DOSE 2 mg
LOCKOUT INTERVAL 10 minutes
MAX LIMIT 25 mg/4 h
[Conc]: 1 mg/mL
>Close and Lock Door Then Press CONFIRM
CHANGE MODE CONFIRM

PCA Infusion Modes (Continued)

Restoring Infusion Following Syringe Empty (Continued)

4. Close and lock security door.
5. Verify programming parameters on summary screen are correct and press **START** key.

A	Second Nurse Summary Morphine	
PCA Dose:	2 mg	
Lockout Interval:	10 minutes	
Max Limit:	25 mg/4 h	
[Conc]:	1 mg/mL	
>Press START		
PAUSE	PRO-GRAM	START

Stopping Infusion

Press and hold **CHANNEL OFF** key on PCA Module for 1 second, until a beep is heard.

*NOTE: If no other channel is active, the System powers down when the **CHANNEL OFF** key is released.*

Selecting Pressure Limit

1. Press **CHANNEL SELECT** key.
2. Press **OPTIONS** key.
3. Press **Pressure Limit** soft key.

NOTE: Option can be selected to change pressure limit:

- Before Infusion Mode is selected.
- Before Infusion starts.

A	Channel Options	2 of 2
Pressure Limit - High		
Prime Set with Syringe		
>Select an Option or EXIT		
PAGE UP	EXIT	

PCA Infusion Modes (Continued)

Selecting Pressure Limit (Continued)

4. To select a pressure limit, press appropriate soft key (**Low**, **Med**, or **High**).
5. Press **CONFIRM** soft key.

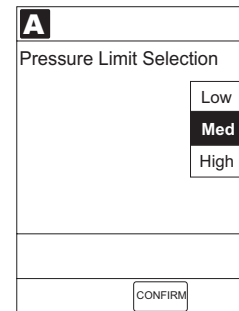

Viewing and Clearing Volume Infused

1. To view volume infused, press **VOLUME INFUSED** soft key from the Main Display.
 - Total volume infused, and time and date volume infused was last cleared is displayed for each channel.

NOTE: Date format is year-month-day.

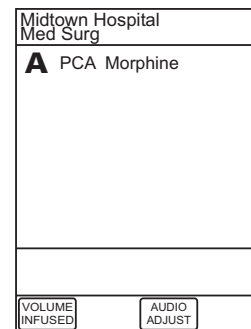

2. To clear volume infused:

NOTE: If no key is pressed, main screen appears after 30 seconds.

- If only selected channels are to be cleared, press soft key next to applicable channel(s) and press **CLEAR CHANNEL** soft key.
 - ◆ Volume clears on selected channel(s).
- If all channels are to be cleared, press **CLEAR ALL** soft key.
- To return to main screen, press **MAIN SCREEN** soft key.

NOTE: Clearing volume infused on a PCA Module does not clear patient history.

Volume Infused		
TOTAL VOLUME (mL)	LAST CLEARED	
A 401.10	08:00	1998-3-10
B 42.50	07:30	1998-3-11
C 478.10	08:00	1998-3-10
D 789.10	12:00	1998-3-10
>Select Channels to Clear or Press CLEAR ALL		
PR/SEC VOLUME	CLEAR ALL	MAIN SCREEN

PCA Infusion Modes (Continued)

Changing Syringe During Infusion

1. To stop infusion, press **PAUSE** key on PCA Module.
2. Unlock the door.
3. Open plunger grippers and syringe barrel clamp.
 - An audio prompt sounds.
 - Red Alarm Status Indicator flashes.
 - **CHECK SYRINGE** scrolls in Channel Message Display.
4. Remove syringe and separate administration set from syringe.

NOTE: *If drug and/or drug concentration is different from previous syringe, attach and prime new administration set.*

5. Reattach administration set to new syringe (refer to “Preparing Infusion” section).
6. Load new syringe (refer to “Preparing Infusion” section).
7. Select syringe type and size (refer to “Preparing Infusion” section).
8. Press **CONFIRM** soft key.
9. Prime administration set (refer to “Preparing Infusion” section).
10. Press **RESTORE** soft key, press **NEXT** soft key, and confirm programming parameters.

OR

Press applicable soft key and use numeric data entry keys.
11. Lock the door.
12. To begin infusion, press **START** soft key.

Powering Off

Powering Off Channel

Refer to the Medley™ Point-of-Care Unit Directions for Use.

Powering Off System

Refer to the Medley™ Point-of-Care Unit Directions for Use.

ALARMS, ERRORS, MESSAGES

To enhance safety and ease of operation, the Medley™ System provides a full range of audio and visual alarms, errors, and messages.

Definitions

Advisory	A sequence of audio and/or visual signals indicating the operating status of the Medley™ Medication Safety System. The audio may be silenced for approximately two minutes by pressing the SILENCE key.
Alarm	An audio and visual signal that a potentially unsafe condition is present. Immediate action is required. The audio may be silenced for approximately two minutes by pressing the SILENCE key.
Error	An audio and/or visual signal that a failure has been detected. Immediate action is required.
Guardrails® Alert	A visual message to help reduce programming errors by indicating a Guardrails® Limit (“soft” or “hard”) has been exceeded. A response is required before programming can continue.
Guardrails® Clinical Advisory	A visual message when a designated drug is selected, to remind clinician of specific hospital standards of practice when programming an IV medication. A specific clinical advisory can be associated with a selected drug within any of the patient care profiles.
Maintenance Reminder	A visual message that, when enabled, appears at startup when scheduled preventive maintenance is due/overdue for any part of the Medley™ System (Point-of-Care Unit or attached module).
Prompt	A visual message, appearing on the bottom line of the Main Display or in the Message Display. The message may be accompanied by an audio signal that can be silenced for twelve seconds by pressing the SILENCE key.

Audio Characteristics

The Point-of-Care Unit and Main Display provide various types of alert information. The characteristics of the accompanying audio sounds are as follows:

Type	Sound	Notes
Advisory	One short beep every two seconds	Variable volume; can be silenced for two minutes.
Alarm	Choice of three alarm audio profiles, selectable in System Configuration	Variable volume; can be silenced for two minutes.
Error (Hardware Detected)	Pairs of long beeps	Fixed maximum decibel volume; cannot be silenced.
Error (Software Detected)	Pairs of long beeps	Fixed maximum decibel volume; can be silenced for two minutes.
Illegal Key Press	Two short beeps	Variable volume; cannot be silenced.
Key Click	One short beep	Fixed minimum volume; can be silenced and disabled in System Configuration.
Prompt	One short beep every two seconds	Variable volume; can be silenced.
Switchover	Two short beeps (e.g. Bolus switching to Continuous).	Variable volume; can be silenced and disabled in System Configuration.

Alarms

Attach Dose Request Cord	Dose Request Cord is detached from device. Dose Request Cord is required for PCA only and PCA+Continuous Infusion modes.	Reattach Dose Request Cord and press RESTART key.
Channel Disconnected	Channel(s) disconnected while in operation or have a communication problem.	To silence alarm and clear message from screen, press CONFIRM soft key. Reattach channel, if desired, ensuring it is securely “clicked” into place at Channel Release Latch. If alarm is still present, replace channel with an operational instrument.
Check Syringe	Plunger grippers opened during infusion and then closed. Infusion stops on affected channel.	Securely lock plunger grippers, press CHANNEL SELECT key, and reselect syringe.
	Syringe barrel clamp opened during infusion and then closed. Infusion stops on affected channel.	Securely lock syringe barrel clamp and press RESTART key.
	Syringe plunger not captured while in idle state. System alarms immediately to indicate potential siphoning condition.	Check for potential siphoning. Ensure administration set clamp (roller/slide) is in closed position. Securely lock plunger grippers over syringe plunger.
	If security door is closed and syringe plunger is not captured, the system will immediately alarm.	
Lock Door	Door unlocked during infusion. System will not infuse with door unlocked.	Lock door and press RESTART key.
Occlusion	Increased back pressure sensed while infusing. Infusion stops on affected channel.	Clear occlusion, press RESTART key or appropriate select control, and then press START soft key.
Syringe Empty	Syringe is empty.	Set up new infusion or press CHANNEL OFF key.
	If syringe is not empty, the syringe plunger travel may be impeded.	Verify syringe plunger movement is unimpeded.
Unit Location Alarm	PCA Module is not in the preferable location to allow locking to the Point-of-Care Unit. Device is not in a tamper evident position.	Detach PCA Module from current position and reattach to the immediate right of the Medley™ Point-of-Care Unit.

Alarms (Continued)

Syringe Adjustment Alarms

When a syringe installation problem is detected, a visual signal is displayed. Text in the display blinks to indicate the location of the problem.

- When problem is corrected, press **CONFIRM** soft key.

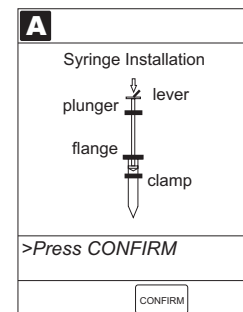
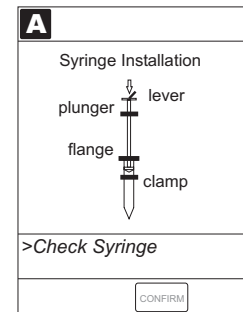

Alarm	Meaning	Response
Check Syringe	Plunger grippers opened during infusion and then closed. Infusion stops on affected channel.	Securely lock plunger grippers, press CHANNEL SELECT key, and reselect syringe.
	Syringe barrel clamp opened during infusion and then closed. Infusion stops on affected channel.	Securely lock syringe barrel clamp and press RESTART key.
	Syringe plunger not captured while in idle state. System alarms after 30 seconds, to indicate potential siphoning condition. If security door is closed and syringe plunger is not captured, the system will immediately alarm.	Check for potential siphoning. Ensure administration set clamp (roller/slide) is in closed position. Securely lock plunger grippers over syringe plunger.
Drive Not Engaged	Drive system disengaged during operation.	Open and close plunger grippers. Ensure syringe is properly installed.

Errors

Error	Meaning	Response
Channel Error	Error detected on infusing channel. Infusion stops on affected channel.	To silence alarm and continue operation of unaffected channels, press CONFIRM soft key. Replace channel with an operational instrument, as required. Service by qualified personnel is required.
Syringe Calibration Required	Error on infusing channel indicating calibration is required. Infusion stops on affected channel. CALIBRATE scrolls in Channel Message Display.	To silence alarm and continue operation of unaffected channels, press CONFIRM soft key. Replace channel with an operational instrument, as required. Service by qualified personnel is required.
Syringe Driver Head Error	Noninfusing channel, with plunger grippers open, senses excessive pressure being applied downward on Drive Head. OCCLUSION scrolls in Channel Message Display.	To silence alarm and continue normal operation, press CONFIRM soft key.

Messages

Message	Meaning	Response
Bolus Complete	Current Bolus Dose completed. Channel running in Continuous Dose if programmed.	None
Infusion Complete	Current infusion completed.	Set up a new infusion or press CHANNEL OFF key.
Load Complete	Current Loading Dose completed. Infusion mode menu available or programmed infusion running.	None
Max Limit Reached	Programmed Max Limit has been reached over time period specified. Infusion paused until time limit has expired.	None. This is a timed event that can be set. To change Max Limit, press CHANNEL SELECT , press SETUP soft key, and unlock door or enter Authorization Code applicable for current Security Access Level.
NEOI (Near End of Infusion)	Syringe almost empty.	None. This is a timed event that can be set. To set or change this option, see "Configurable Settings" section.

Messages (Continued)

Message	Meaning	Response
Panel Locked	Tamper Resist feature is active and a key was pressed.	If appropriate, deactivate Tamper Resist feature using Tamper Resist Control on back of Point-of-Care Unit.
Panel Unlocked	Tamper Resist feature deactivated.	None.
Pause	Pause control pressed, infusion stopped.	To resume infusion, press RESTART key.
PCA Complete	Current PCA Dose complete. Lockout interval begins. Channel running in Continuous Dose if programmed.	None
Syringe Not Recognized	Installed syringe of unknown type and size.	Select and confirm correct syringe type and size, and then press CONFIRM ; or use a syringe type and size that system can automatically and correctly identify. Ensure compatible syringe is loaded. For a list of compatible syringes, refer to Compatible Sets section of this Directions for Use.

Medley™ System Technical Service Manuals are available from ALARIS Medical Systems. They include routine service schedules, interconnect diagrams, component parts lists and descriptions, test procedures and/or references, and other technical information, to assist qualified service personnel in repair and maintenance of each instrument's repairable components. Maintenance procedures are intended to be performed only by qualified personnel, using the service manual and Medley™ Maintenance Software.

Specifications

Bolus Dose Range	Configured according to hospital best practice guidelines.	
Delivery Units	mg, mcg, mL, mg/h, mcg/h, mL/h	
Critical Volume:	The maximum over-infusion which can occur in the event of a single-fault condition will not exceed 2% of nominal syringe fill volume during loading and 1% of maximum syringe travel after syringe loading.	
Dimensions:	4.5" W x 15.0" H x 7.5" D (exclusive of security door).	
Environmental Conditions:	<u>Operating</u>	<u>Storage/Transport</u>
<i>Temperature Range:</i>	41 to 104°F (5 to 40°C)	-4 to 140°F (-20 to 60°C)
<i>Relative Humidity: (Avoid prolonged exposure to relative humidity >85%)</i>	20 to 90% Noncondensing	5 to 85% Noncondensing
<i>Atmospheric Pressure:</i>	525 to 4560 mmHg (700 to 6080 hPa)	375 to 760 mmHg (500 to 1013 hPa)
Equipment Orientation:	To ensure proper operation, the Point-of-Care Unit must remain in an upright position.	
Flow Rate Programming:	The flow rate range is from 0.1 to 999 mL/h as follows:	
	<u>Flow Rates (mL)</u>	<u>Selectable Increments (mL/h)</u>
	0.10 - 9.99	0.01
	10 - 99.9	0.1
	100 - 999	1.0
<i>Rate Restriction by Syringe Size:</i>		
	<u>Syringe Size (mL)</u>	<u>Flow Rate Range (mL/h)</u>
	50/60	0.1 - 999
	30/35	0.1 - 650
	20	0.1 - 500
Fluid Ingress Protection:	IPX1, Drip Proof	
Loading Dose Range:	Configured according to hospital best practice guidelines.	

Specifications (Continued)

- Max Limit Range:** Configured according to hospital best practice guidelines.
- Occlusion Alarm Thresholds:** Three settings:
 Low
 Medium
 High
- Operating Principle:** Positive displacement
- PCA Dose Range:** Configured according to hospital best practice guidelines.
- Rate Accuracy:** The Medley™ PCA Module accuracy rate is $\pm 2\%$ of full scale plunger travel (not including syringe variation).

WARNING

Syringe size and running force, variations of back pressure, or any combination of these may affect rate accuracy. Factors that can influence back pressure are: Administration set configuration, IV solution viscosity, and IV solution temperature. Back pressure may also be affected by type of catheter. Refer to “Trumpet and Start-Up Curves” section in the Appendix for data on how these factors influence rate accuracy.

- Shock Protection:** Type CF, Defibrillator Proof (PCA Module)
 Type BF, Defibrillator Proof (Dose Request Cord)

Time to Alarm, Maximum:

Rate (mL/h)	Occlusion Pressure Limit	
	High	Low
1	120 minutes	37 minutes
5	30 minutes	7 minutes

NOTE: The Maximum Time to Alarm specifications are based on ALARIS Medical Systems' standard operating conditions:

- Atmospheric Pressure: 645 - 795 mmHg*
Back Pressure: 0 mmHg before producing occlusion
Humidity: 20 - 90%
Temperature: 68 \pm 4° F

Specifications (Continued)

Bolus Volume after Occlusion, Maximum:

Bolus Volume at Intermediate Rate (5 mL/h)	
Occlusion Pressure Limit	Bolus Volume
High	.997 mL
Low	.396 mL

Weight: 5.5 lbs

NOTE: Compliance to Standards

The Medley™ Medication Safety System complies with the following standards: UL 60601-1, including A1 and A2; CSA C22.2 No. 601.1, including A1 and A2; IEC/EN 60601-2-24; IEC/EN 60601-1-2, and AAMI ID26.

Configurable Settings

If the configuration settings need to be changed from the Factory Default settings, refer to the Guardrails® Editor Software User Manual or contact ALARIS Medical Systems, Technical Support, for technical, troubleshooting, and preventive maintenance information.

NOTE: With the Profiles feature enabled, the settings are configured independently for each profile. A hospital-defined data set must be uploaded to enable the Profiles feature. Date and Time is a system setting and is the same in all profiles.

System Settings

Refer to the Medley™ Point-of-Care Unit Directions for Use.

Configurable Settings (Continued)

PCA Module Settings

Feature	Default Setting	Options
Authorization Code	None	4-digits between 0-9 One code applies to all profiles
Bolus Delivery Rate	150 mL/hr	75 -500 mL/hr (limited by syringe size)
Bolus Dose	Enabled	Enabled - Disabled
Bolus Dose include in Max. Limit	Disabled	Enabled - Disabled
Dose Request Cord Configuration	Profile B	Profile A, B, C
Loading Dose	Enabled	Enabled - Disabled
Lockout Interval	1 - 180 minutes in 1 minute increments	Min/Max 1-180 minutes
Max Accumulated Dose Range	1 hour limit	Disabled/1, 2 or 4 hour limit
Max Rate	999 mL/h	0.1 - 99.9 mL/h in 0.1 mL/h increments; 100 - 999 mL/h in 1 mL/h increments
NEOI • Alert Time	Disabled	Enabled - Disabled 5 - 25% of remaining infusion
Occlusion Pressure Set Point:	High (800 mmHg)	Low (200 mmHg) Medium (500 mmHg) High (800 mmHg)
Priming	Disabled	Enabled - Disabled
Forced Module Location	Enabled	Enabled - Disabled
Security Access Level	Level 1	Level 1, 2, 3

Compatible Syringes

The Medley™ PCA Module is calibrated and labeled for use with the following single-use disposable luer-lock syringes. Use only the syringe size and type specified on the Main Display. The full list of permitted syringe models is dependent on the PCA Module's software version.

Manufacturer	20cc	30cc	35cc	50cc	60cc
B-D Plastipak	✓	✓		✓	✓
IMS Pump Jet*		✓ ¹			
Monoject	✓		✓		✓
Terumo	✓	✓		✓	✓

¹ Prefilled Morphine Sulfate 1 mg/ml.

***NOTE:** Syringe variability may impact occlusion pressure sensing. The variability may reduce the device's time to alarm and/or may require that a higher alarm pressure limit be programmed.

Compatible Sets

The following administration sets are for use with the Medley™ PCA Module. For additional configurations, contact ALARIS Medical Systems Customer Care at (800) 482-4822.

WARNING

Use only standard, single-use, disposable non-dedicated administration sets with anti-siphon valves, designed for use on syringe-type PCA devices. The use of incompatible administration set may cause improper instrument operation, resulting in inaccurate fluid delivery or other potential hazards.

MODEL	SET DESCRIPTION
30843E	PCA Extension Set 12" - Y-Connector with SmartSite® Needle-Free Valve Port and backcheck valve
30853	PCA Administration Set 70" - Microbore w/Anti-siphon valve, Y-Connector with backcheck valve
30863	PCA Administration Set 63" - Microbore w/Anti-siphon valve
30873	PCA Administration Set 90" - Microbore w/Anti-siphon valve, Y-Connector with backcheck valve
30883	PCA Administration Set 92" - Microbore w/Anti-siphon valve
30893	PCA Administration Set 113" - Microbore w/yellow-striped tubing and anti-siphon valve

Cleaning

Refer to the Medley™ Point of Care Unit Directions for Use.

Inspection Requirements

To ensure the system remains in good operating condition, both regular and periodic inspections are required.

Regular inspections consist of a visual inspection for damage and cleanliness, and performing the procedure described in the “Start-Up” section of this Directions for Use before each usage of the instrument. Regular inspections must be performed by the hospital/facility and if any damage is found, service is required.

WARNING

Failure to perform these inspections may result in improper instrument operation.

REGULAR INSPECTIONS

<u>PROCEDURE</u>	<u>FREQUENCY</u>
INSPECT FOR DAMAGE:	
Exterior Surface	Each usage
Pole Clamp	Each usage
Power Cord	Each usage
Keypad	Each usage
CLEANING	As required
START-UP	Each usage

1. Exterior Surfaces - examine for overall condition and verify:
 - There is no damage, cracks or deformities.
 - Case is clean and free from IV solution residue.
 - Labels and markings are legible.
 - No tape or other foreign material is on sides of case; anything of this nature could prevent proper latching of modules.
 - IUI Connectors have not been damaged.
2. Pole Clamp
Pole Clamp should be secure and functioning.
3. Power Cord Assembly - examine for:
 - Signs of damage, cuts or deformities in cord. If damaged, replace entire cord.
 - Integrity of hospital-grade power plug. Attempt to wiggle blades, to verify they are secure. If any damage is suspected, replace entire cord.
4. Keypad
Check membrane switches for damage.

Periodic inspections of the hardware are required. For detailed instructions on performing periodic inspections and maintenance, refer to the Medley™ Medication Safety System Technical Service Manual and supplemental service bulletins, and Medley™ Maintenance Software.

CAUTION

Periodic inspections should only be performed by qualified service personnel.

Service Information

NOTE: *If the instrument shows evidence of damage in transit, notify the carrier's agent immediately. Do not return damaged equipment to the factory before the carrier's agent has authorized repairs.*

If the instrument fails to respond as described in this document and the cause cannot be determined, do not use the instrument. Contact ALARIS Medical Systems Technical Support.

Customer Service

Information or assistance may be obtained by calling one of the following Customer Service numbers:

United States	(800) 482-4822
Canada:	(800) 387-8309

Technical Support

Technical support, service information, applications, and manuals may be obtained by contacting an ALARIS Medical Systems representative.

United States	(800) 854-7128, extension 6003
Canada:	
Eastern	(800) 908-9918
Western	(800) 908-9919

When submitting any request for service, include:

- full description of difficulty experienced
- instrument settings
- administration set/lot number
- solution(s) used
- message displayed at time of difficulty

Product Return

If it is necessary to return the instrument for service, obtain a return authorization number prior to shipment. Carefully package the instrument (preferably in the original packaging), reference the return authorization information, and return it to the appropriate service or distribution center. ALARIS Medical Systems does not assume any responsibility for loss of, or damage to, returned instruments while in transit.

WARNING

Instruments returned from the service depot to your facility may be set to factory defaults and not have a hospital-defined data set loaded. Biomedical personnel in the facility are responsible for checking-in the instrument and ensuring the current hospital-approved data set is loaded.

THIS PAGE
INTENTIONALLY
LEFT BLANK

Trumpet and Start-Up Curves

In this instrument, as with all infusion systems, the action of the pumping mechanism and variations in individual syringes and administration sets cause short-term fluctuations in rate accuracy. The following graphs show typical performance of the system, as follows:

1. Accuracy during various time periods over which fluid delivery is measured (trumpet curves).
2. Delay in onset of fluid flow when infusion commences (start-up curves).

Trumpet and start-up curves have been provided for 0.1 mL/h, 1.0 mL/h and 5.0 mL/h. Measurements for trumpet curve rates above 5.0 mL/h are also not provided, as the volume of the syringe will be displaced in a very short time with a rate of up 999 mL/h. Accuracy, however, is assured with the design implementation.

Trumpet curves are named for their characteristic shape. They display discrete accuracy data averaged over particular time periods or “observation windows”, not continuous data versus operating time.

Over long observation windows, short-term fluctuations have little effect on accuracy, as represented by the flat part of the curve. As the observation window is reduced, short-term fluctuations have greater effect, as represented by the “mouth” of the trumpet. Knowledge of system accuracy over various observation windows may be of interest when certain drugs are being administered.

Because the clinical impact of short-term fluctuations on rate accuracy depends on the half-life of the drug being infused and on the degree of intravascular integration, the clinical effect cannot be determined from the trumpet

curves alone. Knowledge of the start-up characteristics should also be considered.

The start-up curves represent continuous flow rate versus operating time for two hours from the start of the infusion. They exhibit the delay in onset of delivery due to mechanical compliance and provide a visual representation of uniformity. Trumpet curves are derived from the second hour of this data.

Under conditions of -100 mmHg, +100 mmHg, and +300 mmHg pressures, the Medley™ PCA Module typically exhibits a long-term accuracy offset of approximately 0.2% or less from the mean value.

NOTE: Tests conducted in accordance with IEC/EN 60601-2-24, “Particular requirements for safety of infusion pumps and controllers” and AAMI ID26-1998 “Medical electrical equipment - Part 2: Particular requirements for the safety of infusion pumps and controllers”, using B-D Plastipak 60cc Syringe and ALARIS Medical Systems® Administration Set (30910).

Trumpet and Start-Up Curves (Continued)

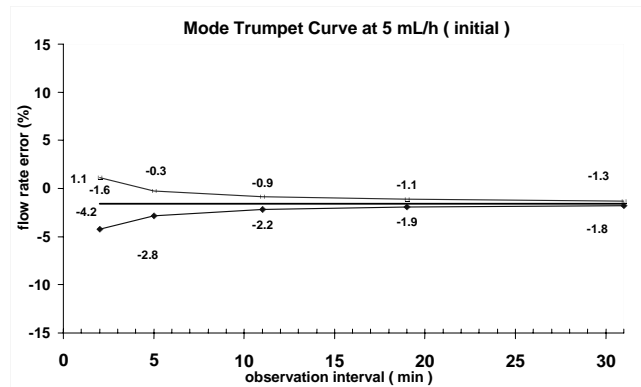
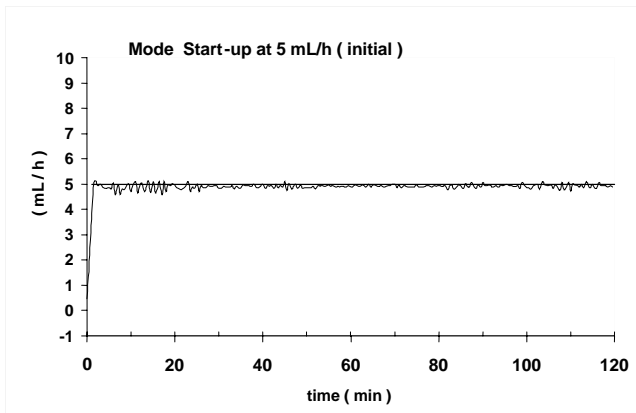
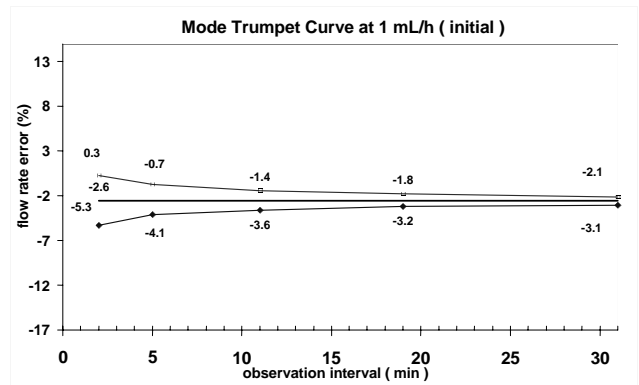
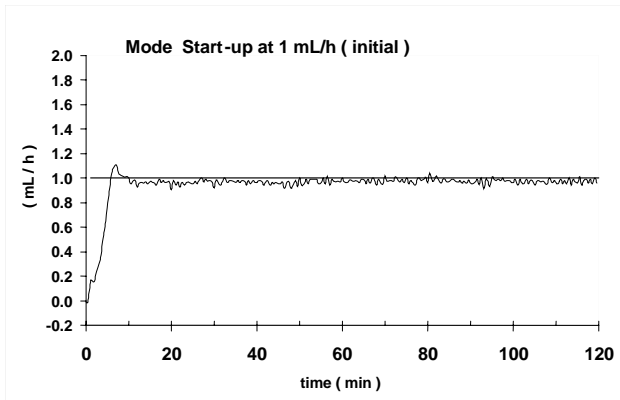
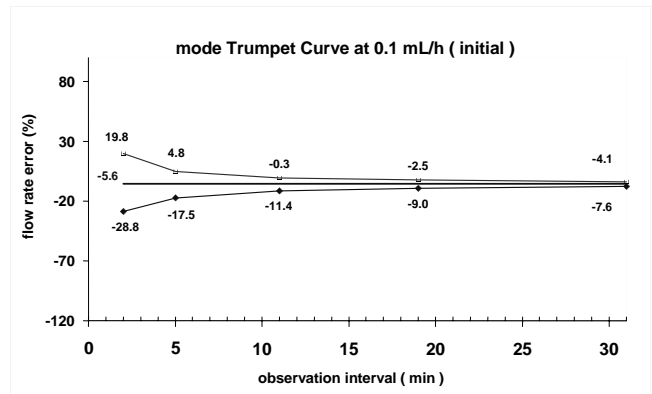
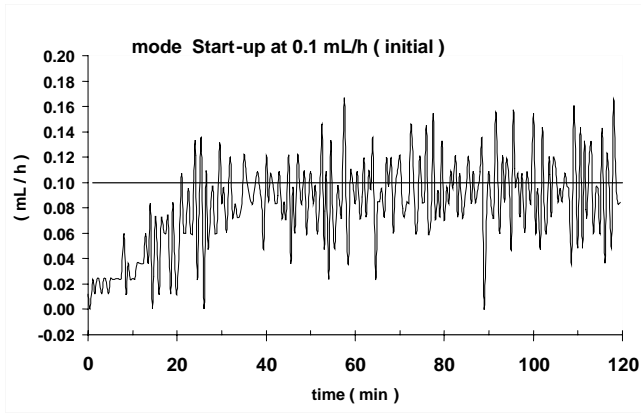

Legend:
 ■ Maximum rate error
 — Overall rate error
 ◆ Minimum rate error

ALARIS[®]

MEDICAL SYSTEMS

ALARIS Medical Systems, Inc.
10221 Wateridge Circle
San Diego, California 92121 U.S.A.

Mail:
P.O. Box 85335
San Diego, California 92186-5335 U.S.A.

ALARIS[®], ALARIS Medical Systems[®], Guardrails[®], and Medley[™] are trademarks and registered trademarks of ALARIS Medical Systems, Inc. All other trademarks belong to their respective owners.

Patents, Brevets, Brevet , Patente, Brevetti, Brevettato, 登 録 第 , Ned. Octrooi, Sv.:
US – 5,601,445; 5,713,856; 5,781,442; 5,800,387; 5,836,910; 5,941,846. **AU** – 693,662; 703,178; 703,203; 719,254; 728,366.
AT – 0,225,158. **BE** – 0,225,158. **CA** – 1,258,212; 2,026,518. **CH** – +0,225,158. **DE** – P3686558.3. **FR** – 0,225,158. **GB** – 0,225,158.
IT – 0,225,158. **JP** – 1,816,872. **NL** – 0,225,158. **SE** - 0,225,158. **TW** – NI-107963. Other Patents Pending.